

TEST REPORT

Product Name : CM3588 Computer on Module
Model Number : CM3588

Prepared for : BOARDCON EMBEDDED DESIGN LIMITED
Address : 2508-2509 Haofang Tianji Plaza, 11008 Beihuan Avenue,
Nanshan District, Shenzhen, Guangdong, China. 518051

Prepared by : EMTEK (SHENZHEN) CO., LTD.
Address : Building 69, Majialong Industry Zone, Nanshan District,
Shenzhen, Guangdong, China

Tel: (0755) 26954280
Fax: (0755) 26954282

Report Number : ENS2410150124W00101R
Date(s) of Tests : May 28, 2024 to September 3, 2024
Date of Issue : October 23, 2024



TABLE OF CONTENTS

1. DESCRIPTION OF STANDARDS AND RESULTS (EUT)	6
2. GENERAL INFORMATION	7
2.1. Description of Device (EUT)	7
2.2. Independent Operation Modes	7
2.3. Test Manner	8
2.4. Description of Support Device	8
2.5. Description of Test Facility	9
2.6. Measurement Uncertainty	9
3. MEASURING DEVICE AND TEST EQUIPMENT	10
4. CONDUCTED EMISSIONS FROM THE AC MAINS POWER PORTS	13
4.1. Block Diagram of Test Setup	13
4.2. Limits.....	13
4.3. Test Procedure	14
4.4. Measuring Results	14
5. ASYMMETRIC MODE CONDUCTED EMISSIONS AT WIRED NETWORK PORTS	17
5.1. Block Diagram of Test Setup	17
5.2. Limits.....	17
5.3. Test Procedure	18
5.4. Measuring Results	18
6. RADIATED EMISSION MEASUREMENT (UP TO 1GHZ)	20
6.1. Block Diagram of Test Setup	20
6.2. Radiated Limit	20
6.3. Test Procedure	21
6.4. Measuring Results	21
7. RADIATED EMISSION MEASUREMENT (ABOVE 1GHZ)	24
7.1. Block Diagram of Test Setup	24
7.2. Radiated Limit	24
7.3. Test Procedure	26
7.4. Measuring Results	26
8. HARMONIC CURRENT EMISSION MEASUREMENT	29
8.1. Block Diagram of Test Setup	29
8.2. Standard Limits	29
8.3. Test Procedure	30
8.4. Test Results	30
9. VOLTAGE FLUCTUATION AND FLICKER MEASUREMENT	31
9.1. Block Diagram of Test Setup	31
9.2. Standard Limits	31
9.3. Test Procedure	31
9.4. Test Results	31
10. IMMUNITY GENERAL PERFORMANCE CRITERIA DESCRIPTION	33
11. ELECTROSTATIC DISCHARGE	34
11.1. Test Specification.....	34
11.2. Block Diagram of Test Setup.....	34
11.3. Test Procedure	34
11.4. Test Results	35
12. CONTINUOUS RF ELECTROMAGNETIC FIELD DISTURBANCES	36
12.1. Test Specification.....	36
12.2. Block Diagram of Test Setup.....	36
12.3. Test procedure	36
12.4. Test results.....	37

13. ELECTRICAL FAST TRANSIENTS/BURST	38
13.1. Test Specification	38
13.2. Block Diagram of Test Setup	38
13.3. Test Procedure	39
13.4. Test Results	39
14. SURGES	40
14.1. Test Specification	40
14.2. Block Diagram of Test Setup	40
14.3. Test Procedure	40
14.4. Test results	41
15. CONTINUOUS INDUCED RF DISTURBANCES	42
15.1. Test Specification	42
15.2. Block Diagram of Test Setup	42
15.3. Test Procedure	42
15.4. Test results	43
16. POWER FREQUENCY MAGNETIC FIELD	44
16.1. Test Specification	44
16.2. Block Diagram of Test Setup	44
16.3. Test Procedure	44
16.4. Test Results	45
17. VOLTAGE DIPS AND INTERRUPTIONS	46
17.1. Test Specification	46
17.2. Block Diagram of Test Setup	46
17.3. Test Procedure	46
17.4. Test results	47
18. PHOTOGRAPHS	48
18.1. Photos of Conducted Emissions from the AC Mains Power Ports	48
18.2. Photos of Asymmetric Mode Conducted Emissions at Wired Network Ports	49
18.3. Photos of Radiation Emission Measurement	50
18.4. Photo of Harmonic / Flicker Measurement	51
18.5. Photo of Electrostatic Discharges	51
18.6. Photo of Continuous RF Electromagnetic Field Disturbances	52
18.7. Photos of Electrical Fast Transients/Burst	53
18.8. Photos of Surges	54
18.9. Photos of Continuous Induced RF Disturbances	55
18.10. Photo of Power Frequency Magnetic Field	56
18.11. Photo of Voltage Dips And Interruptions	56

APPENDIX (Photos of the EUT)

Modified Information

Version	Report No.	Revision Date	Summary
	ENS2403270179W00101R	/	Original Report
M1	ENS2410150124W00101R	/	Upgrade the information of applicant and manufacturer for name and address, product name product photo, trademark and model number
Note: This product is an extension of original one under report number: ENS2403270179W00101R. For upgrade the information of applicant and manufacturer for name and address, product name, product photo, trademark and model number, It is not necessary to verify.			



TEST REPORT DESCRIPTION

Applicant : BOARDCON EMBEDDED DESIGN LIMITED
Address : 2508-2509 Haofang Tianji Plaza, 11008 Beihuan Avenue, Nanshan District, Shenzhen, Guangdong, China. 518051
Manufacturer : BOARDCON EMBEDDED DESIGN LIMITED
Address : 2508-2509 Haofang Tianji Plaza, 11008 Beihuan Avenue, Nanshan District, Shenzhen, Guangdong, China. 518051
EUT : CM3588 Computer on Module
Model No. : CM3588
Trade Mark : 

Measurement Procedure Used:

EN 55032:2015+A1:2020
EN IEC 61000-3-2: 2019+A1: 2021
EN 61000-3-3: 2013+A2: 2021
EN 55035: 2017+A11: 2020
(IEC 61000-4-2:2008, IEC 61000-4-3:2020, IEC 61000-4-4:2012, IEC61000-4-5:2017, IEC 61000-4-6:2013, IEC 61000-4-8:2009, IEC 61000-4-11:2020)

The device described above is tested by EMTEK (SHENZHEN) CO., LTD. to determine the maximum emission levels emanating from the device and the severe levels of the device can endure and its performance criterion. The measurement results are contained in this test report and EMTEK (SHENZHEN) CO., LTD. is assumed full of responsibility for the accuracy and completeness of these measurements. Also, this report shows that the EUT (Equipment Under Test) is technically compliant with the above table standards requirement.

This report applies to above tested sample only and shall not be reproduced in part without written approval of EMTEK (SHENZHEN) CO., LTD.

Date of Test : May 28, 2024 to September 3, 2024

Prepared by : 
Una Yu/Editor

Reviewer : 
Joe Xia/Supervisor

Approved & Authorized Signer : 
Lisa Wang/Manager

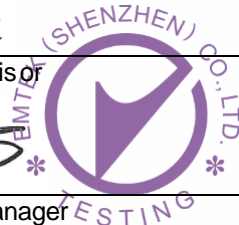

1. DESCRIPTION OF STANDARDS AND RESULTS (EUT)

EMISSION				
Description of Test Item		Standard	Limits	Results
Conducted Emissions From the AC Mains Power Ports		EN 55032	Class A	Pass
Asymmetric mode conducted emissions	Wired network ports		Class A	Pass
	Optical fibre ports		Class A	N/A
	Broadcast receiver tuner ports		Class A	N/A
	Antenna ports		Class A	N/A
Conducted differential voltage emissions	TV broadcast receiver tuner ports		Class A	N/A
	RF modulator output ports		Class A	N/A
	FM broadcast receiver tuner ports		Class A	N/A
Radiated emissions at frequencies up to 1 GHz			Class A	Pass
Radiated emissions at frequencies above 1 GHz			Class A	Pass
Radiated emissions from FM receivers			Table A.6	N/A
Outdoor units of home satellite receiving systems			Table A.7	N/A
Harmonic Current Emissions			EN IEC 61000-3-2	Class A
Voltage Fluctuation and Flicker		EN 61000-3-3	Section 5	Pass
IMMUNITY				
Description of Test Item		Basic Standard	Performance Criteria	Results
Electrostatic Discharge	Enclosure ports	IEC 61000-4-2	B	Pass
Continuous RF electromagnetic field disturbances	Enclosure ports	IEC 61000-4-3	A	Pass
Electrical fast transients/burst	AC mains power ports	IEC 61000-4-4	B	Pass
	Analogue/digital data ports		B	Pass
	DC network power ports		N/A	N/A
Surges	AC mains power ports	IEC 61000-4-5	B	Pass
	Analogue/digital data ports		C	Pass
	DC network power ports		N/A	N/A
Continuous induced RF disturbances	AC mains power ports	IEC 61000-4-6	A	Pass
	Analogue/digital data ports		A	Pass
	DC network power ports		N/A	N/A
Power frequency magnetic field	Enclosure ports	IEC 61000-4-8	A	Pass
Voltage dips and interruptions	AC mains power ports	IEC 61000-4-11	B,C	Pass
Note: N/A is an abbreviation for not applicable.				

2. GENERAL INFORMATION

2.1. Description of Device (EUT)

EUT	:	CM3588 Computer on Module
Model Number	:	CM3588
Applicant	:	BOARDCON EMBEDDED DESIGN LIMITED
Address	:	2508-2509 Haofang Tianji Plaza, 11008 Beihuan Avenue, Nanshan District, Shenzhen, Guangdong, China. 518051
Manufacturer	:	BOARDCON EMBEDDED DESIGN LIMITED
Address	:	2508-2509 Haofang Tianji Plaza, 11008 Beihuan Avenue, Nanshan District, Shenzhen, Guangdong, China. 518051
Power Supply	:	AC 230V/50Hz by Adapter Adapter: Model: SOY-1200300EU-056 Input: 100-240V~50/60Hz, 1.2A Max Output: 12V, 3A, 36W

2.2. Independent Operation Modes

Test Mode

Mode A. On mode

- A1. Normal work (All functions are turned on and working properly)
- A2. DP
- A3. USB
- A4. Ping

Mode B. Standby mode

Mode C. Off mode

2.3. Test Manner

Test Items	Test Voltage	Operation Modes	Worst Case
Conducted disturbance at mains Terminals	As the Power Supply information	Mode A,B,C	Mode A3
Asymmetric mode conducted emissions at Wired network ports	As the Power Supply information	Mode A4	Mode A4
Radiated emissions at frequencies up to 1 GHz	As the Power Supply information	Mode A,B,C	Mode A3
Radiated emissions at frequencies above 1 GHz	As the Power Supply information	Mode A,B,C	Mode A3
Harmonic Current Emissions	As the Power Supply information	Mode A,B	\
Voltage Fluctuation and Flicker	As the Power Supply information	Mode A,B	\
Electrostatic Discharge	As the Power Supply information	Mode A,B	\
Continuous RF electromagnetic field disturbances	As the Power Supply information	Mode A,B	\
Electrical fast transients/burst	As the Power Supply information	Mode A,B	\
Surges	As the Power Supply information	Mode A,B	\
Continuous induced RF disturbances	As the Power Supply information	Mode A,B	\
Power frequency magnetic field	As the Power Supply information	Mode A,B	\
Voltage dips and interruptions	As the Power Supply information	Mode A,B	\

2.4. Description of Support Device

LCD Monitor : Manufacturer: Lenovo
M/N: 9227-AE6
S/N:4M0293084302824
CE, FCC

Notebook : Manufacturer: Lenovo
M/N: WB0205140E
CE, FCC

Portable hard disk : M/N:WDBACY500ABL
S/N: WXG1EBOSX219
CE, FCC

Notes:

- 1.All the equipment/cables were placed in the worst-case configuration to maximize the emission during the test.
- 2.Grounding was established in accordance with the manufacturer's requirements and conditions for the intended use.

2.5. Description of Test Facility

Site Description
Name of Firm : EMTEK (SHENZHEN) CO., LTD.
Site Location : Building 69, Majialong Industry Zone, Nanshan District, Shenzhen, Guangdong, China

2.6. Measurement Uncertainty

Test Item	Uncertainty
Conducted Emission Uncertainty	: 2.08dB(9k~150kHz Conduction 1#) 2.40dB(150k-30MHz Conduction 1#)
Radiated Emission Uncertainty (3m 1# Chamber)	: 4.46dB (30M~1GHz Polarize: H) 5.04dB (30M~1GHz Polarize: V) 4.92dB (1~6GHz)
Uncertainty for Flicker test	: 0.07%
Uncertainty for Harmonic test	: 1.8%
Uncertainty for C/S Test	: 1.45(Using CDN Test) 2.37(Using EM Clamp Test)
Uncertainty for R/S Test	: 2.10dB(80MHz-200MHz) 1.76dB(200MHz-1000MHz)
Uncertainty for test site temperature and humidity	: 0.6°C 4%

3. MEASURING DEVICE AND TEST EQUIPMENT

For Conducted Emissions at the AC Mains Power Ports

Equipment	Manufacturer	Model No.	Serial No.	Last Cal.	Cal. Interval
EMI Test Receiver	Rohde & Schwarz	ESCI	101384	2024/5/11	1Year
AMN	Rohde & Schwarz	ENV216	101161	2024/5/10	1Year
AMN	Kyoritsu	KNW-407	8-1492-9	2024/5/11	1Year

For Asymmetric Mode Conducted Emissions at Wired Network Ports

Equipment	Manufacturer	Model No.	Serial No.	Last Cal.	Cal. Interval
EMI Test Receiver	Rohde & Schwarz	ESCI	101384	2024/5/11	1Year
AAN	TESEQ	ISN T800	30327	2023/11/10	1Year
AAN	TESEQ	ISN T8-CAT6	32186	2024/5/12	1Year

For Radiated Emission Measurement (3m)

Equipment	Manufacturer	Model No.	Serial No.	Last Cal.	Cal. Interval
Pre-Amplifier	HP	8447F	2944A07999	2024/5/11	1Year
EMI Test Receiver	Rohde & Schwarz	ESCI	101414	2024/5/11	1Year
Bilog Antenna	Schwarzbeck	VULB9163	141	2022/6/26 2024/6/15	2 Year
Horn antenna	Schwarzbeck	BBHA9120D	9120D-1177	2023/5/12	2 Year
Pre-Amplifie	Bonn	BLMA0118-5G	2213967B-02	2023/10/23	1Year
Spectrum Analyzer	Rohde & Schwarz	FSV40	100967	2024/5/10	1Year
Horn antenna	Schwarzbeck	BBHA9170	9170-399	2023/5/12	2 Year
Pre-Amplifie	Lunar EM	LNA18G26-40	J1012131010 001	2024/5/11	1Year
Pre-Amplifie	Lunar EM	LNA26G40-40	J1013131028 001	2024/5/11	1Year
Loop Antenna	Schwarzbeck	FMZB1519	1519-012	2023/5/12	2 Year

For Harmonic Current / Flicker Measurement

Equipment	Manufacturer	Model No.	Serial No.	Last Cal.	Cal. Interval
45KVA AC Power source	Teseq	NSG 1007-45/45KV A	1305A02873	2024/5/11	1 Year
Signal conditioning Unit	Teseq	CCN 1000-3	1305A02873	2024/5/11	1 Year
Impedance network	Teseq	INA2197/37A	1305A02873	2024/5/11	1 Year
Impedance network	Teseq	INA 2196/75A	1305A02874	2024/5/11	1 Year
Proffline 2100 AC Switching Unit	Teseq	NSG 2200-3	A22714	2024/5/11	1 Year

For Electrostatic Discharge Immunity

Equipment	Manufacturer	Model No.	Serial No.	Last Cal.	Cal. Interval
ESD Tester	EMTEST	Dito	P2220263883	2023/10/20	1 Year

For Continuous RF Electromagnetic Field Disturbances Immunity

Equipment	Manufacturer	Model No.	Serial No.	Last Cal.	Cal. Interval
Power Amplifier	MILMEGA	AS0102-55	1018770	2024/5/11	1 Year
RF Power Meter. Dual Channel	BOONTON	4232A	10539	2024/5/11	1 Year
Log.-Per. Antenna	SCHWARZBECK	STLP 9129-7/16	3050	N/A	N/A
Signal Generator	Agilent	N5181A	MY50145187	2024/5/11	1 Year
50ohm Diode Power Sensor	BOONTON	51011EMC	36164	2024/5/11	1 Year
Field Strength Meter	DARE	RSS1006A	10I00037SNO 22	2024/5/20	1 Year
Multi-function interface system	DARE	CTR1009B	12I00250SNO 72	N/A	N/A
Automatic switch group	DARE	RSW1004A	N/A	N/A	N/A
Power Amplifier	MILMEGA	AS1860-50	1059346	2024/5/11	1 Year
Power Amplifier	Vectawave	VBA 1000-600C	133627	2023/10/23	1 Year
Directional Coupler	BONN	BDC 0810-50/1500	2229689	2023/10/23	1 Year
Audio Analyzer	R&S	UPV	101473	2024/5/11	1 Year

For Electrical Fast Transient / Burst Immunity

Equipment	Manufacturer	Model No.	Serial No.	Last Cal.	Cal. Interval
Burst Tester	HAEFELY	PEFT4010	080981-16	2024/5/12	1Year
Coupling Clamp	HAEFELY	IP-4A	147147	2024/5/12	1Year
Three phase CDN	Teseq	CDN 163	202	2024/5/12	1 Year

For Surges Immunity

Equipment	Manufacturer	Model No.	Serial No.	Last Cal.	Cal. Interval
Controller	HAEFELY	Psurge 8000	174031	2024/5/11	1Year
Impulse Module	HAEFELY	PIM 100	174124	2024/5/11	1Year
Coupling Decoupling	HAEFELY	PCD 130	172181	2024/5/11	1Year
Coupling Module	HAEFELY	PCD122	174354	2024/5/11	1Year
Impulse Module	HAEFELY	PIM 120	174435	2024/5/11	1Year
Coupling Module	HAEFELY	PCD 126A	174387	2024/5/11	1Year
Impulse Module	HAEFELY	PIM 110	174391	2024/5/11	1Year
Impulse Module	HAEFELY	PIM 150	178707	2024/5/12	1Year
Impulse Module	PMI	PCDN8	190422	2024/5/12	1Year

For Continuous Induced RF Disturbances Immunity

Equipment	Manufacturer	Model No.	Serial No.	Last Cal.	Cal. Interval
Continuous Wave Simulator	EMTEST	CWS500C	0900-12	2024/5/10	1Year
CDN	EMTEST	CDN-M2	51001001001 0	2024/5/11	1Year
CDN	EMTEST	CDN-M3	0900-11	2024/5/11	1Year
EM Injection Clamp	EMTEST	F-2031-23MM	368	2024/5/12	1Year
Attenuator	EMTEST	100W 6dB	/	2024/5/10	1Year

		DC-3G			
Signal Generator	ifn	2023B	1702128	2024/5/10	1Year
CDN	LUTHI	CDN L-801 M2/M3	2606	2024/5/11	1Year
Three phase CDN	TESEQ	CDN M332S	32655	2024/5/11	1 Year
Three phase CDN	TESEQ	CDN M432S	33670	2024/5/11	1 Year
Three phase CDN	TESEQ	CDN M432-3LNS	34048	2024/5/11	1 Year
Three phase CDN	TESEQ	CDN M532S	33799	2024/5/11	1 Year
Current Injection Clamp	FCC	F-120-9	140302	2024/5/11	1 Year
Power meter	AGILENT	E4418B	MY45102886	2024/5/10	1 Year
Directional coupler	SKET	DC_0110000 M-100W	SK201808030 1	2024/5/10	1 Year
Audio Test System	AUDIO PRECISION	ATS-1	41100	2024/5/10	1 Year

For Power Frequency Magnetic Field Immunity

Equipment	Manufacturer	Model No.	Serial No.	Last Cal.	Cal. Interval
Magnetic Field Tester	HAEFELY	MAG100	250040.1	2024/5/10	1Year
Magnetic Field Tester	HTEC	HMFG 1000	223701	2023/10/23	1Year

For Voltage Dips and Interruptions Immunity

Equipment	Manufacturer	Model No.	Serial No.	Last Cal.	Cal. Interval
45KVA AC Power source	Teseq	NSG 1007-45/45KV A	1305A02873	2024/5/11	1 Year
Signal conditioning Unit	Teseq	CCN 1000-3	1305A02873	2024/5/11	1 Year
Impedance network	Teseq	INA2197/37A	1305A02873	2024/5/11	1 Year
Impedance network	Teseq	INA 2196/75A	1305A02874	2024/5/11	1 Year
Proflin 2100 AC Switching Unit	Teseq	NSG 2200-3	A22714	2024/5/11	1 Year

4. CONDUCTED EMISSIONS FROM THE AC MAINS POWER PORTS

4.1. Block Diagram of Test Setup

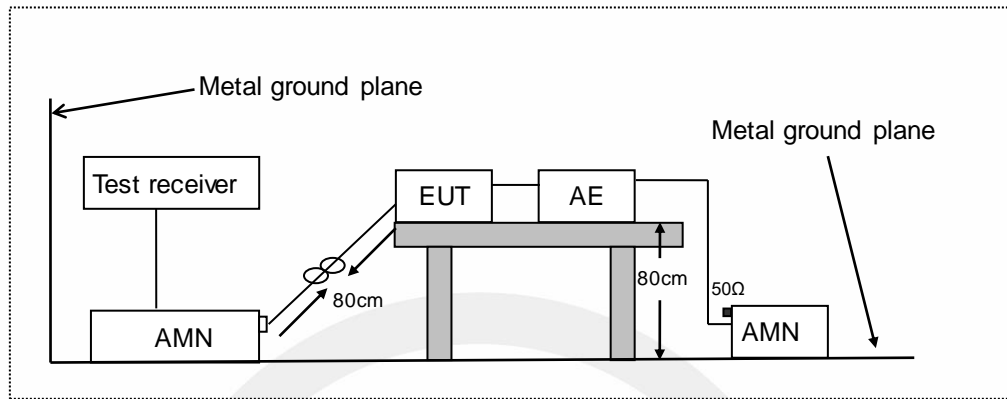

AMN: Artificial Mains Network
 AE: Associated equipment
 EUT: Equipment under test

4.2. Limits

Class A Limit

Frequency range MHz	Coupling device	Detector type / bandwidth	Class A limits dB(μ V)
0.15 to 0.5	AMN	Quasi Peak / 9 kHz	79
0.5 to 30			73
0.15 to 0.5	AMN	Average / 9 kHz	66
0.5 to 30			60

Class B Limit

Frequency range MHz	Coupling device (see Table A.8)	Detector type / bandwidth	Class B limits dB(μ V)
0.15 to 0.5	AMN	Quasi Peak / 9 kHz	66 to 56
0.5 to 5			56
5 to 30			60
0.15 to 0.5	AMN	Average / 9 kHz	56 to 46
0.5 to 5			46
5 to 30			50

4.3. Test Procedure

The EUT was placed on a desk 0.8 m height from the metal ground plane and 0.4 m from the conducting wall of the shielding room and it was kept at least 0.8 m from any other grounded conducting surface. The size of the table will nominally be 1.5 m x1.0 m.

The rear of the arrangement shall be flush with the back of the supporting tabletop unless that would not be possible or typical of normal use.

All units of equipment forming the system under test (includes the EUT as well as connected peripherals and associated equipment or devices) shall be arranged such that a nominal 0.1 m separation is achieved between the neighboring units.

Connect EUT to the power mains through a artificial mains network (AMN). Where the mains cable supplied by the manufacturer is longer than 1 m, the excess should be folded at the centre into a bundle no longer than 0.4 m, so that its length is shortened to 1 m.

All the support units are connecting to the other AMN.

The AMN provides 50 ohm coupling impedance for the measuring instrument.

The CISPR states that the AMN with 50 ohm and 50 microhenry should be used.

Both sides of AC line were checked for maximum conducted interference.

The frequency range from 150 kHz to 30 MHz was sweep.

Set the test-receiver system to quasi peak detect function and average detect function, and to measure the conducted emissions values.

Test results were obtained from the following equation:

$$\text{Emission Level (dB}\mu\text{V)} = \text{AMN Factor (dB)} + \text{Cable Loss (dB)} + \text{Reading (dB}\mu\text{V)}$$

$$\text{Margin (dB)} = \text{Emission Level (dB}\mu\text{V)} - \text{Limit (dB}\mu\text{V)}$$

4.4. Measuring Results

PASS

All the modes were tested and the data of the worst modes are attached the following pages.

Temperature	:	26.9°C
Humidity	:	49%
Atmospheric Pressure	:	101kpa
Test Engineer	:	CSL
Test Date	:	2024.6.6

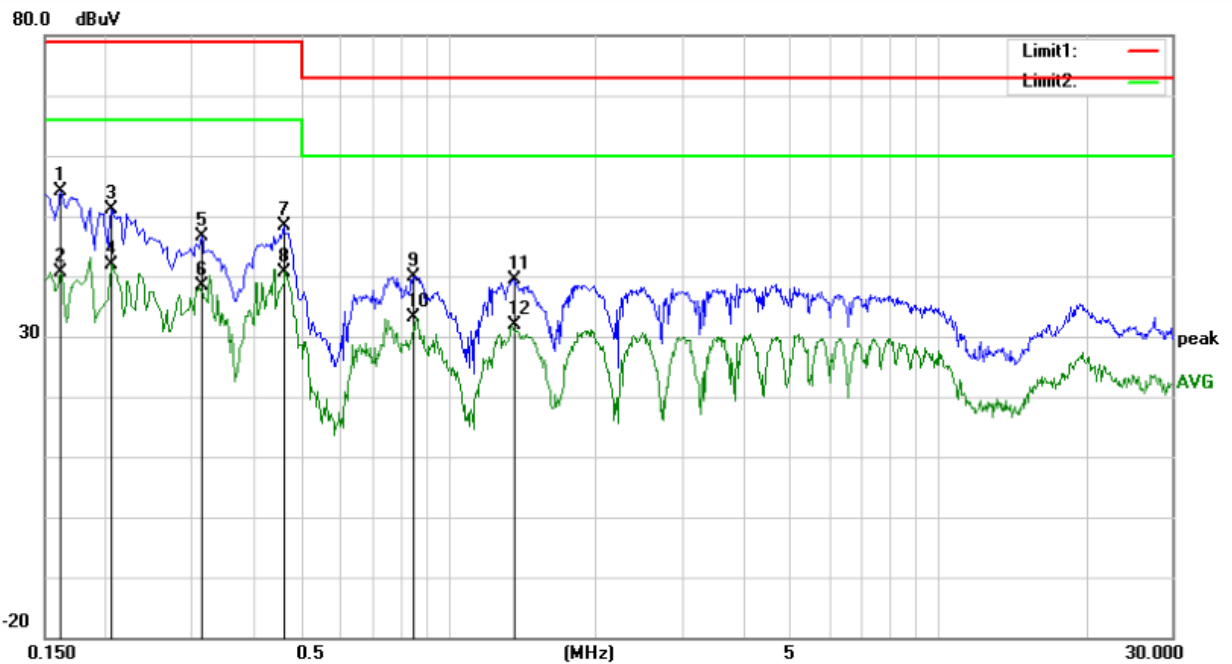

Site Conduction #1 Phase: **L1** Temperature: 26.9

No.	Mk.	Freq. MHz	Reading Level dBuV	Correct Factor dB	Measure- ment dBuV	Limit dBuV	Over dB	Detector	Comment
1		0.1620	44.09	9.92	54.01	79.00	-24.99	QP	
2		0.1620	30.68	9.92	40.60	66.00	-25.40	AVG	
3		0.2060	41.33	9.90	51.23	79.00	-27.77	QP	
4	*	0.2060	31.97	9.90	41.87	66.00	-24.13	AVG	
5		0.3140	36.66	9.92	46.58	79.00	-32.42	QP	
6		0.3140	28.38	9.92	38.30	66.00	-27.70	AVG	
7		0.4620	38.43	9.91	48.34	79.00	-30.66	QP	
8		0.4620	30.80	9.91	40.71	66.00	-25.29	AVG	
9		0.8500	29.98	9.99	39.97	73.00	-33.03	QP	
10		0.8500	23.14	9.99	33.13	60.00	-26.87	AVG	
11		1.3660	29.45	10.02	39.47	73.00	-33.53	QP	
12		1.3660	21.87	10.02	31.89	60.00	-28.11	AVG	

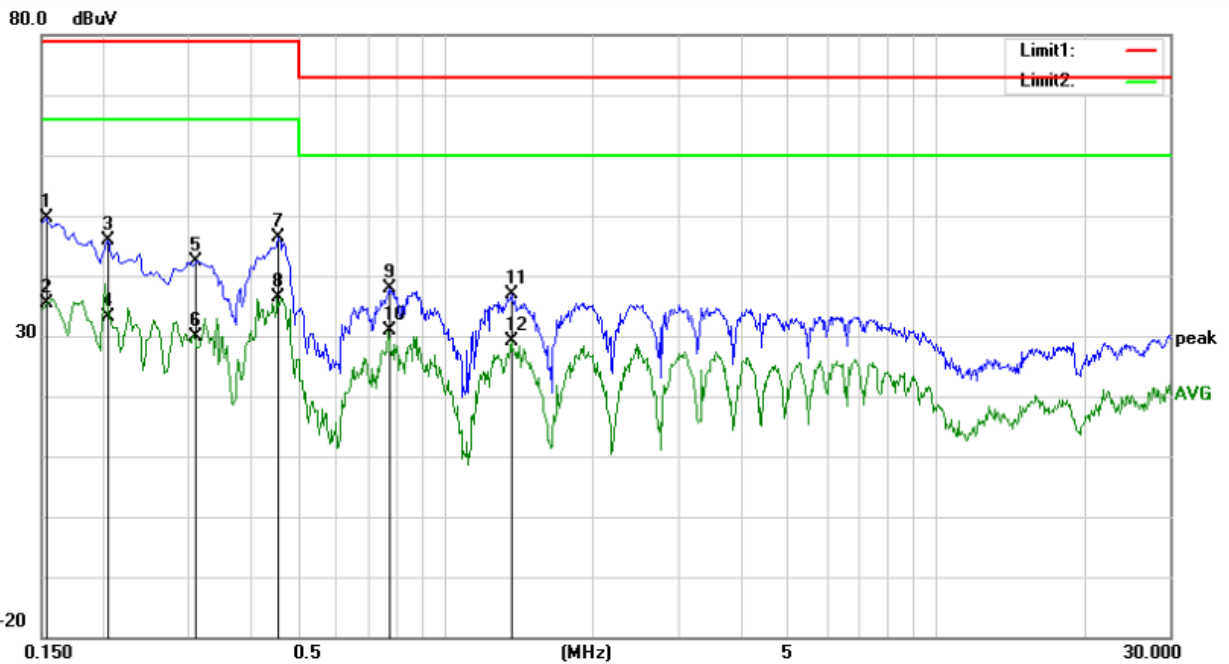

Site Conduction #1

Phase: **N**

Temperature: 26.9

No.	Mk.	Freq.	Reading Level	Correct Factor	Measurement	Limit	Over	Detector	Comment
		MHz	dBuV	dB	dBuV	dBuV	dB		
1		0.1540	39.68	9.93	49.61	79.00	-29.39	QP	
2		0.1540	25.45	9.93	35.38	66.00	-30.62	AVG	
3		0.2060	36.04	9.90	45.94	79.00	-33.06	QP	
4		0.2060	23.14	9.90	33.04	66.00	-32.96	AVG	
5		0.3100	32.38	9.92	42.30	79.00	-36.70	QP	
6		0.3100	19.88	9.92	29.80	66.00	-36.20	AVG	
7		0.4580	36.43	9.91	46.34	79.00	-32.66	QP	
8		0.4580	26.54	9.91	36.45	66.00	-29.55	AVG	
9		0.7740	27.80	9.98	37.78	73.00	-35.22	QP	
10	*	0.7740	20.88	9.98	30.86	60.00	-29.14	AVG	
11		1.3660	26.84	10.02	36.86	73.00	-36.14	QP	
12		1.3660	19.21	10.02	29.23	60.00	-30.77	AVG	

5. ASYMMETRIC MODE CONDUCTED EMISSIONS AT WIRED NETWORK PORTS

5.1. Block Diagram of Test Setup

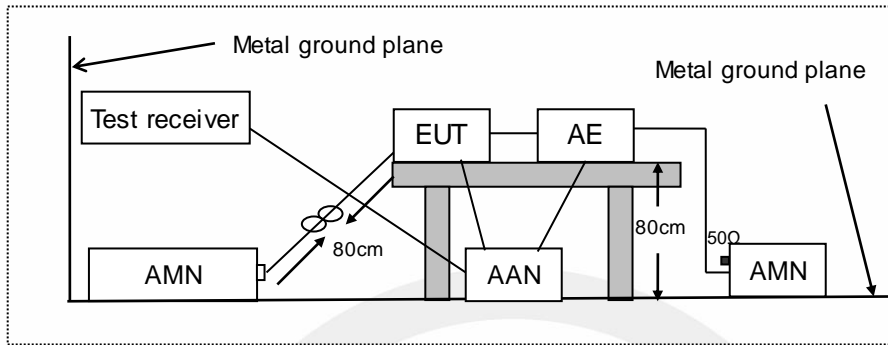

AMN: Artificial mains network
 AE: Associated equipment
 EUT: Equipment under test
 AAN: Asymmetric artificial network

5.2. Limits

Class A Limit

Frequency range (MHz)	Coupling device	Detector type / bandwidth	Class A voltage limits dB(μ V)	Class A current limits dB(μ A)
0.15 to 0.5	AAN	Quasi Peak / 9 kHz	97 to 87	N/A
0.5 to 30			87	
0.15 to 0.5	AAN	Average / 9 kHz	84 to 74	
0.5 to 30			74	
0.15 to 0.5	CVP and current probe	Quasi Peak / 9 kHz	97 to 87	53 to 43
0.5 to 30			87	43
0.15 to 0.5	CVP and current probe	Average / 9 kHz	84 to 74	40 to 30
0.5 to 30			74	30
0.15 to 0.5	Current Probe	Quasi Peak / 9 kHz	N/A	53 to 43
0.5 to 30				43
0.15 to 0.5	Current Probe	Average / 9 kHz		40 to 30
0.5 to 30				30

Class B Limit

Frequency range (MHz)	Coupling device (see Table A.8)	Detector type / bandwidth	Class B voltage limits dB(μ V)	Class B current limits dB(μ A)
0.15 to 0.5	AAN	Quasi Peak / 9 kHz	84 to 74	N/A
0.5 to 30			74	

0.15 to 0.5	AAN	Average / 9 kHz	74 to 64	
0.5 to 30			64	
0.15 to 0.5	CVP and current probe	Quasi Peak / 9 kHz	84 to 74	40 to 30
0.5 to 30			74	30
0.15 to 0.5	CVP and current probe	Average / 9 kHz	74 to 64	30 to 20
0.5 to 30			64	20
0.15 to 0.5	Current Probe	Quasi Peak / 9 kHz	N/A	40 to 30
0.5 to 30				30
0.15 to 0.5	Current Probe	Average / 9 kHz		30 to 20
0.5 to 30				20

Note:

The choice of coupling device and measurement procedure is defined in Annex C. Screened ports including TV broadcast receiver tuner ports are measured with a common-mode impedance of 150 Ω. This is typically accomplished with the screen terminated by 150 Ω. to earth. AC mains ports that also have the function of a wired network port shall meet the limits given in Table A.10.

The measurement shall cover the entire frequency range.

The application of the voltage and/or current limits is dependent on the measurement procedure used. Refer to Table C.1 for applicability.

Measurement is required at only one EUT supply voltage and frequency.

Applicable to ports listed above and intended to connect to cables longer than 3 m.

5.3. Test Procedure

The EUT is put on the plane 0.8m high above the ground by insulating support and connected to the AC mains through artificial mains network(AMN) or connected to the wired network port through an asymmetric artificial network(ANN). AMN provided a 50ohm coupling impedance for the tested equipment AC mains port, ANN provided a common mode (asymmetric mode) impedance of 150 Ω to the wired network port under test. Both sides of AC line and the wired network line are investigated to find out the maximum conducted emission according to the EN 55032 regulations during conducted emission measurement.

The bandwidth of the receiver is set at 9kHz in 150kHz~30MHz. The frequency range from 150kHz to 30MHz is investigated.

Test results were obtained from the following equation:

$$\text{Emission Level (dB}\mu\text{V)} = \text{ANN Factor (dB)} + \text{Cable Loss (dB)} + \text{Reading (dB}\mu\text{V)}$$

$$\text{Margin (dB)} = \text{Emission Level (dB}\mu\text{V)} - \text{Limit (dB}\mu\text{V)}$$

5.4. Measuring Results

PASS

Please see the attached pages.

Temperature	:	26.9°C
Humidity	:	49%
Atmospheric Pressure	:	101kpa
Test Engineer	:	CSL
Test Date	:	2024.6.6

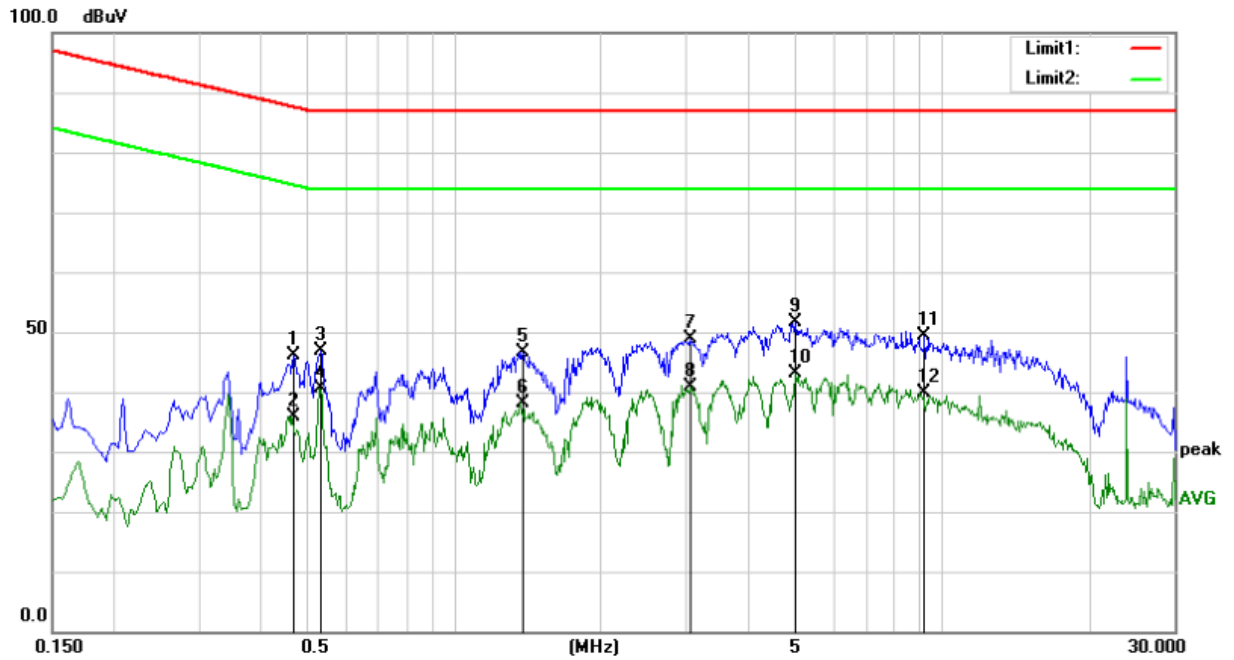

Site Conduction #1 Phase: Temperature: 26.9

No.	Mk.	Freq. MHz	Reading Level dBuV	Correct Factor dB	Measure- ment dBuV	Limit dBuV	Over dB	Detector	Comment
1		0.4700	35.92	10.27	46.19	87.51	-41.32	QP	
2		0.4700	25.53	10.27	35.80	74.51	-38.71	AVG	
3		0.5340	36.69	10.25	46.94	87.00	-40.06	QP	
4		0.5340	30.44	10.25	40.69	74.00	-33.31	AVG	
5		1.3820	36.48	10.12	46.60	87.00	-40.40	QP	
6		1.3820	28.01	10.12	38.13	74.00	-35.87	AVG	
7		3.0460	38.70	10.08	48.78	87.00	-38.22	QP	
8		3.0460	30.76	10.08	40.84	74.00	-33.16	AVG	
9		5.0180	41.60	10.05	51.65	87.00	-35.35	QP	
10	*	5.0180	33.12	10.05	43.17	74.00	-30.83	AVG	
11		9.2060	39.15	10.12	49.27	87.00	-37.73	QP	
12		9.2060	29.68	10.12	39.80	74.00	-34.20	AVG	

6. RADIATED EMISSION MEASUREMENT (UP TO 1GHz)

6.1. Block Diagram of Test Setup

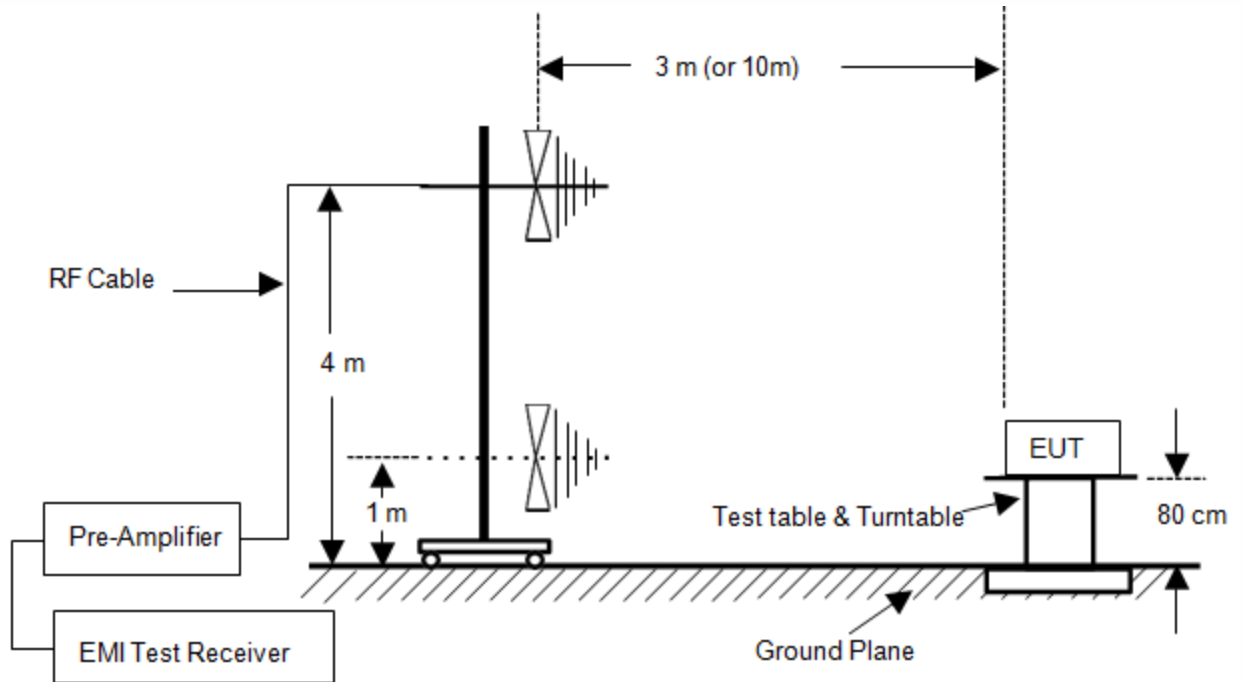

6.2. Radiated Limit

Class A Limit

Frequency range MHz	Measurement			limits dB(μV/m)
	Facility	Distance (m)	Detector type / bandwidth	
30 to 230	OATS/SAC	10	Quasi Peak / 120 kHz	40
230 to 1 000				47
30 to 230	OATS/SAC	3		50
230 to 1 000				57

Class B Limit

Frequency range MHz	Measurement			Class B limits dB(μV/m)
	Facility	Distance (m)	Detector type / bandwidth	
30 to 230	OATS/SAC	10	Quasi Peak / 120 kHz	30
230 to 1 000				37
30 to 230	OATS/SAC	3		40
230 to 1 000				47

6.3. Test Procedure

The EUT was placed on a non-conductive table whose total height equaled 80cm. All units of equipment forming the system under test (includes the EUT as well as connected peripherals and associated equipment or devices) shall be arranged such that a nominal 0.1 m separation is achieved between the neighboring units. Where the mains cable supplied by the manufacturer is longer than 1 m, the excess should be folded at the centre into a bundle no longer than 0.4 m, so that its length is shortened to 1 m.

The EUT was set 3 meters (or 10 meters) away from the receiving antenna that was mounted on a non-conductive mast. The antenna can move up and down between 1 to 4 meters to find out the maximum emission level.

The turntable can rotate 360 degree to determine the position of the maximum emission level.

The initial testing identified the frequency that has the highest disturbance relative to the limit while operating the EUT in typical modes of operation and cable positions in a test setup representative of typical system configuration.

The identification of the frequency of highest emission with respect to the limit was found by investigating emissions at a number of significant frequencies. The probable frequency of maximum emission had been found and that the associated cable and EUT configuration and mode of operation had been identified.

The bandwidth of the Receiver is set at 120 kHz.

Test results were obtained from the following equation:

$$\text{Emission level (dB}\mu\text{V/m)} = \text{Antenna Factor} - \text{Amp Factor} + \text{Cable Loss} + \text{Reading}$$

$$\text{Margin (dB)} = \text{Emission Level (dB}\mu\text{V/m)} - \text{Limit (dB}\mu\text{V/m)}$$

6.4. Measuring Results

PASS

All the modes were tested and the data of the worst modes are attached the following pages.

Temperature	:	23.7°C
Humidity	:	59%
Atmospheric Pressure	:	101kpa
Test Engineer	:	ZL
Test Date	:	2024.5.31

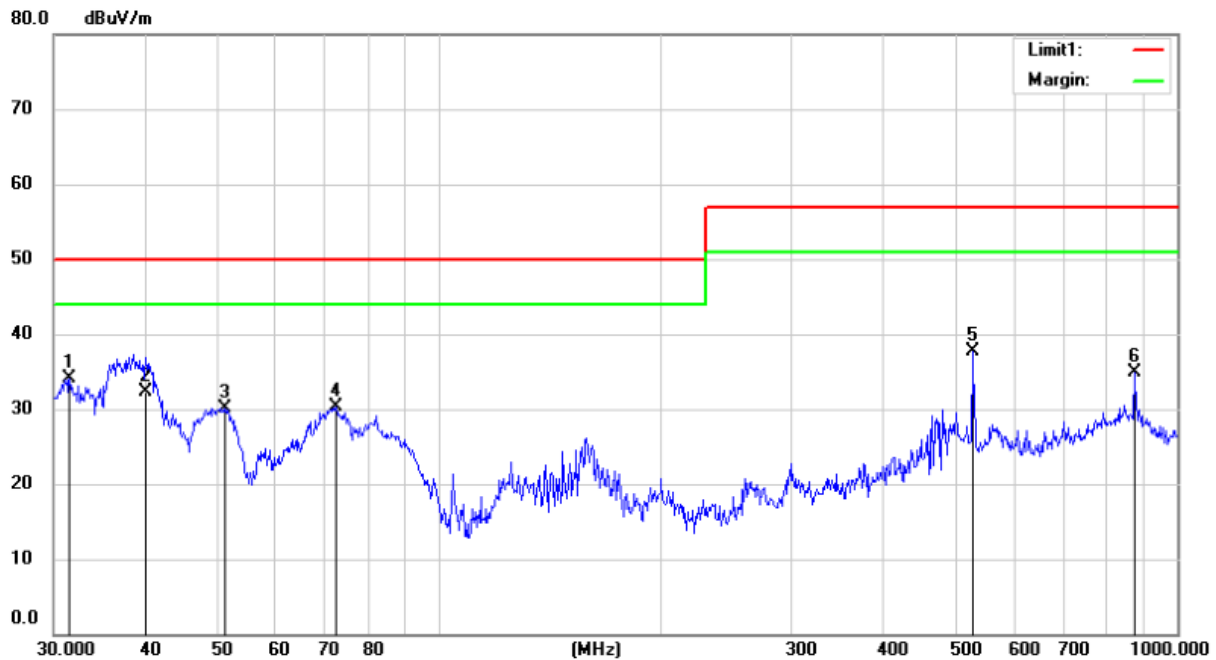

Site 3m Chamber #3 Polarization: **Vertical** Temperature: 23.7 C

No.	Mk.	Freq. MHz	Reading Level dBuV	Correct Factor dB	Measure- ment dBuV/m	Limit dBuV/m	Over dB	Antenna Height cm	Table Degree degree	Comment
1	*	31.5095	50.61	-16.45	34.16	50.00	-15.84	QP		
2		39.9942	47.17	-14.94	32.23	50.00	-17.77	QP		
3		51.1210	44.04	-13.94	30.10	50.00	-19.90	QP		
4		72.3375	46.73	-16.47	30.26	50.00	-19.74	QP		
5		528.2458	43.70	-6.04	37.66	57.00	-19.34	QP		
6		875.2470	34.14	0.82	34.96	57.00	-22.04	QP		

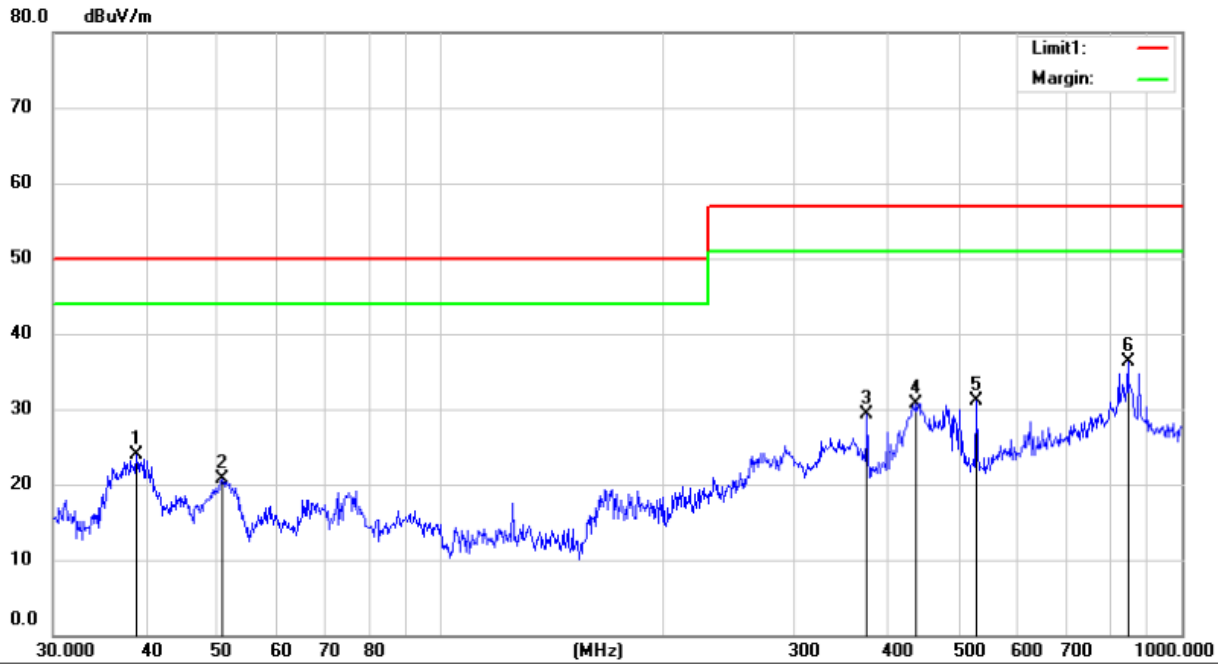

No.	Mk.	Freq. MHz	Reading Level dBuV	Correct Factor dB	Measure- ment dBuV/m	Limit dBuV/m	Over dB	Antenna Height cm	Table Degree	Detector	Comment
1		38.8878	39.21	-15.24	23.97	50.00	-26.03			QP	
2		50.7636	34.64	-13.95	20.69	50.00	-29.31			QP	
3		375.9385	38.39	-9.06	29.33	57.00	-27.67			QP	
4		438.6554	38.60	-7.89	30.71	57.00	-26.29			QP	
5		528.2458	37.11	-6.04	31.07	57.00	-25.93			QP	
6	*	845.0877	34.40	1.91	36.31	57.00	-20.69			QP	

7. RADIATED EMISSION MEASUREMENT (ABOVE 1GHz)

7.1. Block Diagram of Test Setup

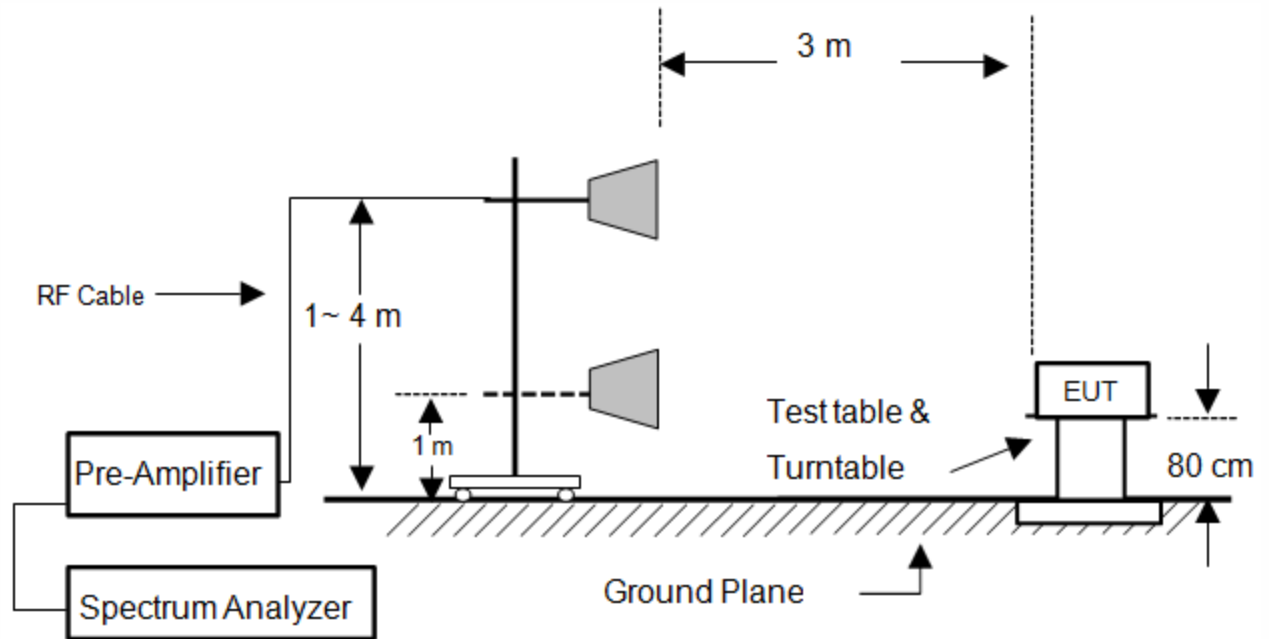

7.2. Radiated Limit

Class A Limit

Frequency range (MHz)	Measurement			limits dB(μ V/m)
	Facility	Distance (m)	Detector type/ bandwidth	
1000 to 3000	FSOATS	3	Average / 1 MHz	56
3000 to 6000				60
1000 to 3000			Peak /1 MHz	76
3000 to 6000				80

Note: The highest internal source of an EUT is defined as the highest frequency generated or used within the EUT or on which the EUT operates or tunes. If the highest frequency of the internal sources of the EUT is less than 108 MHz, the measurement shall only be made up to 1 GHz. If the highest frequency of the internal sources of the EUT is between 108 MHz and 500 MHz the measurement shall only be made up to 2 GHz. If the highest frequency of the internal sources of the EUT is between 500 MHz and 1 GHz, the measurement shall only be made up to 5 GHz. If the highest frequency of the internal sources of the EUT is above 1 GHz, the measurement shall be made up to 5 times the highest frequency or 6 GHz, whichever is less.

Class B Limit

Frequency range (MHz)	Measurement			Class B limits dB(μ V/m)
	Facility	Distance (m)	Detector type/ bandwidth	
1000 to 3000	FSO ATS	3	Average / 1 MHz	50
3000 to 6000				54
1000 to 3000			Peak /1 MHz	70
3000 to 6000				74

Note: The highest internal source of an EUT is defined as the highest frequency generated or used within the EUT or on which the EUT operates or tunes. If the highest frequency of the internal sources of the EUT is less than 108 MHz, the measurement shall only be made up to 1 GHz. If the highest frequency of the internal sources of the EUT is between 108 MHz and 500 MHz the measurement shall only be made up to 2 GHz. If the highest frequency of the internal sources of the EUT is between 500 MHz and 1 GHz, the measurement shall only be made up to 5 GHz. If the highest frequency of the internal sources of the EUT is above 1 GHz, the measurement shall be made up to 5 times the highest frequency or 6 GHz, whichever is less.

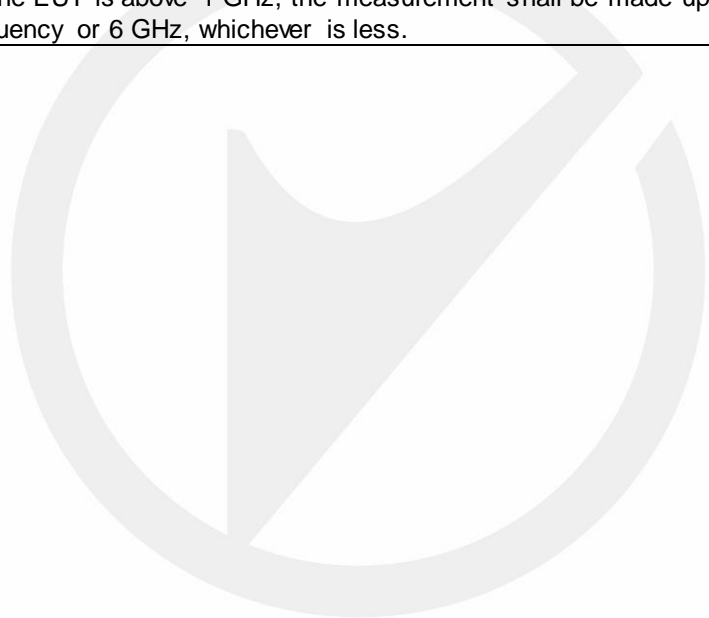

7.3. Test Procedure

The EUT was placed on a non-conductive table whose total height equaled 80cm. All units of equipment forming the system under test (includes the EUT as well as connected peripherals and associated equipment or devices) shall be arranged such that a nominal 0.1 m separation is achieved between the neighboring units. Where the mains cable supplied by the manufacturer is longer than 1 m, the excess should be folded at the centre into a bundle no longer than 0.4 m, so that its length is shortened to 1 m.

The EUT was set 3 meters away from the receiving antenna that was mounted on a non-conductive mast. The antenna can move up and down between 1 to 4 meters to find out the maximum emission level.

The turntable can rotate 360 degree to determine the position of the maximum emission level.

The initial testing identified the frequency that has the highest disturbance relative to the limit while operating the EUT in typical modes of operation and cable positions in a test setup representative of typical system configuration.

The identification of the frequency of highest emission with respect to the limit was found by investigating emissions at a number of significant frequencies. The probable frequency of maximum emission had been found and that the associated cable and EUT configuration and mode of operation had been identified.

The frequency range above 1GHz the measuring instrument use RBW=1 MHz and VBW=3 MHz.

Test results were obtained from the following equation:

Emission level (dB μ V/m) = Antenna Factor -Amp Factor +Cable Loss + Reading

Margin (dB) = Emission Level (dB μ V/m) - Limit (dB μ V/m)

7.4. Measuring Results

PASS

All the modes were tested and the data of the worst modes are attached the following pages.

Temperature	:	23.7°C
Humidity	:	59%
Atmospheric Pressure	:	101kpa
Test Engineer	:	ZL
Test Date	:	2024.5.31

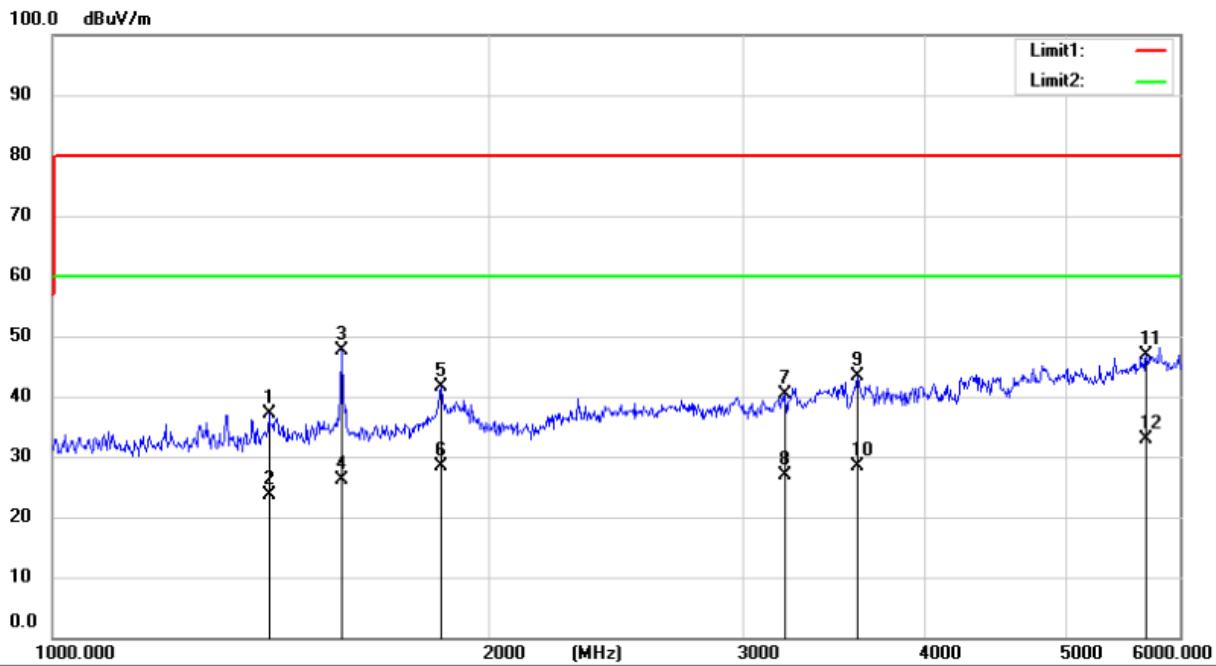

Site 3m Chamber #3 Polarization: **Vertical** Temperature: 23.7 C

No.	Mk.	Freq. MHz	Reading Level dBuV	Correct Factor dB	Measure- ment dBuV/m	Limit dBuV/m	Over dB	Antenna Height cm	Table Degree	Comment
1		1410.604	51.56	-14.52	37.04	80.00	-42.96	peak		
2		1410.604	38.06	-14.52	23.54	60.00	-36.46	AVG		
3		1582.001	61.29	-13.76	47.53	80.00	-32.47	peak		
4		1582.001	39.83	-13.76	26.07	60.00	-33.93	AVG		
5		1852.184	52.48	-10.74	41.74	80.00	-38.26	peak		
6		1852.184	39.24	-10.74	28.50	60.00	-31.50	AVG		
7		3204.781	48.67	-8.29	40.38	80.00	-39.62	peak		
8		3204.781	35.07	-8.29	26.78	60.00	-33.22	AVG		
9		3594.181	51.04	-7.60	43.44	80.00	-36.56	peak		
10		3594.181	36.01	-7.60	28.41	60.00	-31.59	AVG		
11		5685.998	48.66	-1.69	46.97	80.00	-33.03	peak		
12	*	5685.998	34.54	-1.69	32.85	60.00	-27.15	AVG		

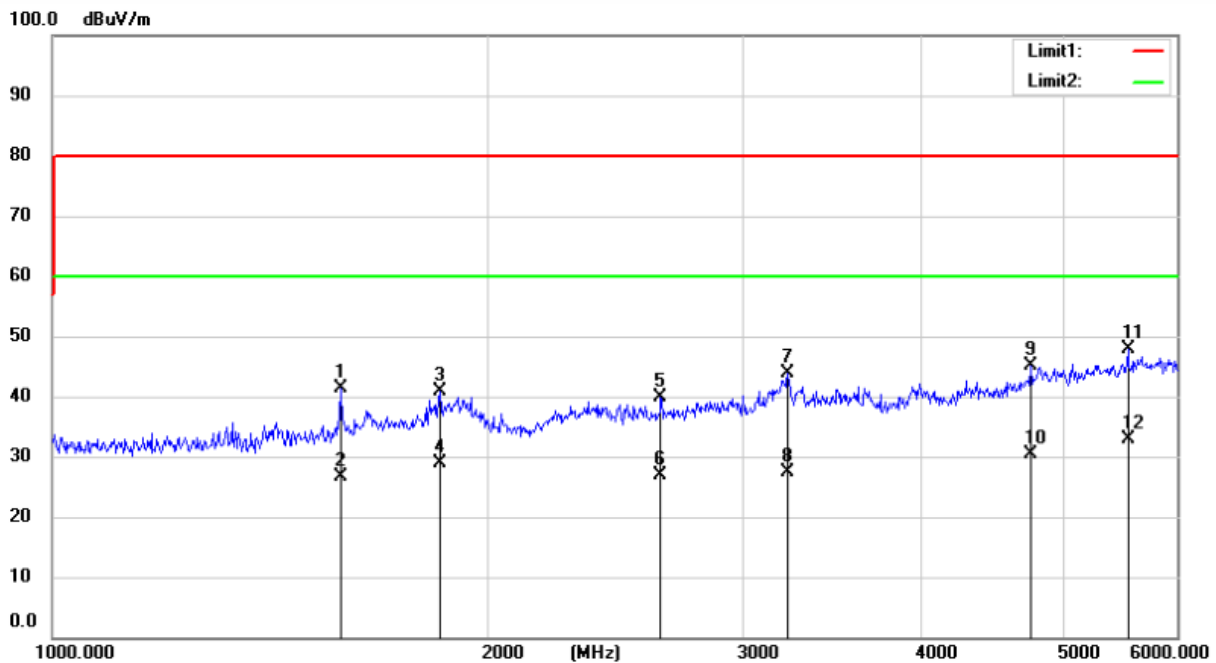

Site 3m Chamber #3 Polarization: **Horizontal** Temperature: 23.7 C

No.	Mk.	Freq.	Reading Level	Correct Factor	Measurement	Limit	Over	Antenna Height	Table Degree	
		MHz	dBuV	dB	dBuV/m	dBuV/m	dB	cm	degree	Comment
1		1582.001	55.11	-13.76	41.35	80.00	-38.65			peak
2		1582.001	40.43	-13.76	26.67	60.00	-33.33			AVG
3		1852.184	51.64	-10.74	40.90	80.00	-39.10			peak
4		1852.184	39.54	-10.74	28.80	60.00	-31.20			AVG
5		2636.209	49.33	-9.57	39.76	80.00	-40.24			peak
6		2636.209	36.51	-9.57	26.94	60.00	-33.06			AVG
7		3227.832	52.19	-8.33	43.86	80.00	-36.14			peak
8		3227.832	35.75	-8.33	27.42	60.00	-32.58			AVG
9		4753.260	48.95	-3.83	45.12	80.00	-34.88			peak
10		4753.260	34.22	-3.83	30.39	60.00	-29.61			AVG
11		5545.141	49.73	-1.89	47.84	80.00	-32.16			peak
12	*	5545.141	34.89	-1.89	33.00	60.00	-27.00			AVG

8. HARMONIC CURRENT EMISSION MEASUREMENT

8.1. Block Diagram of Test Setup

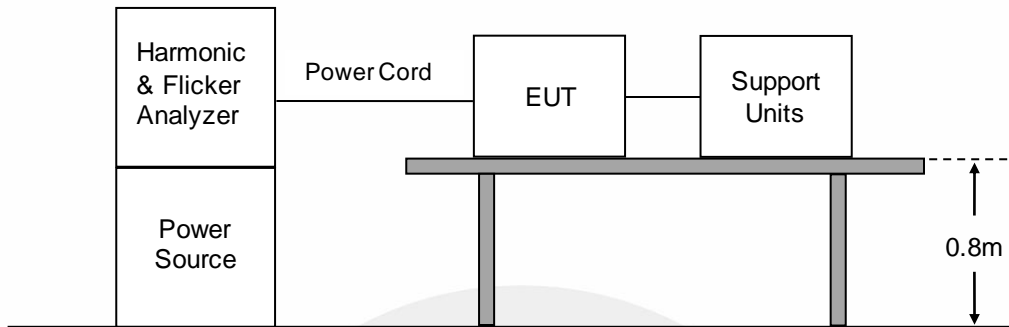

8.2. Standard Limits

EN 61000-3-2, CLASS A

Harmonic current emissions evaluate the potential for the EUT to cause distortion on the AC power lines. It is applicable to electrical and electronic equipment having an input current ≤ 16 A per phase, and intended to be connected to public low-voltage distribution systems.

Table 1 – Limits for Class A equipment

Harmonic order n	Maximum permissible harmonic current (A)
Odd harmonics	
3	2.30
5	1.14
7	0.77
9	0.40
11	0.33
13	0.21
$15 \leq n \leq 39$	$0.15 \frac{0.15}{n}$
Even harmonics	
2	1.08
4	0.43
6	0.30
$8 \leq n \leq 40$	$0.23 \frac{8}{n}$

8.3. Test Procedure

The measurement of harmonic currents shall be performed as follows: i. For each harmonic order, measure the 1.5 s smoothed r.m.s. harmonic current in each DFT time window as defined in EN / IEC 61000-4-7:2009. ii. Calculate the arithmetic average of the measured values from the DFT time windows, over the entire observation period Short cyclic ($T \text{ cycle} \leq 2.5 \text{ min}$). Because of synchronisation to meet the requirements for repeatability in 5%.

8.4. Test Results

N/A

As specified on section 7 and above figure of EN 61000-3-2, the limits are not specified for equipment with a rated power of 75W or less. The EUT meets the above condition, so it conforms to EN 61000-3-2.



9. VOLTAGE FLUCTUATION AND FLICKER MEASUREMENT

9.1. Block Diagram of Test Setup

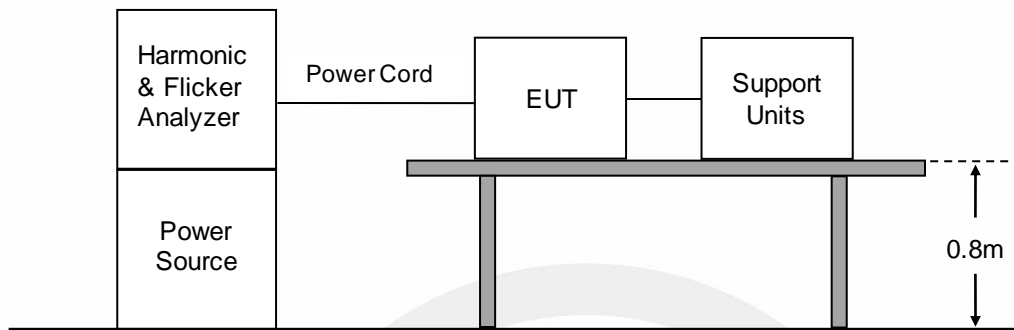

9.2. Standard Limits

EN 61000-3-3 Limits

The objective of voltage changes, voltage fluctuations and flicker in public low voltage supply systems during equipment with rated current ≤ 16 A per phase, ensures that home appliances and certain other electrical equipment do not adversely affect lighting equipment when connected to the same power system.

Voltage Fluctuation and Flicker Limits:

- the value of Pst shall not be greater than 1.0;
- the value of Plt shall not be greater than 0.65;
- the value of $d(t)$ during a voltage change shall not exceed 3.3 % for more than 500 ms;
- the relative steady-state voltage change, d_c , shall not exceed 3.3 %;
- the maximum relative voltage change, d_{max} , shall not exceed 4.0 %;

9.3. Test Procedure

The total impedance of the test circuit, excluding the appliance under test, but including the internal impedance of the supply source, shall be equal to the reference impedance. The stability and tolerance of the reference impedance shall be adequate to ensure that the overall accuracy of 8% is achieved during the whole assessment procedure.

9.4. Test Results

PASS

Please see the attached page.

Flicker Test Summary per EN/IEC61000-3-3 Ed. 3.0 (2013) (Run time)

EUT: **Tested by:**
Test category: All parameters(European limits) **Test Margin: 100**
Test date: 2024/6/2 **Start time: 13:52:55** **End time: 14:03:22**
Test duration (min): 10 **Data file name: WIN2105_F-002025.cts_data**
Comment:
Customer:

Test Result: Pass **Status: Test Completed**

Pstj and limit line

European Limits



Parameter values recorded during the test:

Vrms at the end of test (Volt):	230.84			
T-max (mS):	0.0	Test limit (mS):	500.0	Pass
Highest dc (%):	0.00	Test limit (%):	3.30	Pass
Highest dmax (%):	-0.12	Test limit (%):	4.00	Pass
Highest Pst (10 min. period):	0.294	Test limit:	1.000	Pass

10. IMMUNITY GENERAL PERFORMANCE CRITERIA DESCRIPTION

General performance criteria are defined in EN 55035 clause 8.2, 8.3 and 8.4. These criteria shall be used during the testing of primary functions where no relevant annex is applicable.

When assessing the impact of a disturbance on a function, the assessment should take into consideration the function's performance prior to the application of the disturbance and only identify as failures those changes in performance that are a result of the disturbance.

EN 55035:

Performance criterion A

The equipment shall continue to operate as intended without operator intervention. No degradation of performance, loss of function or change of operating state is allowed below a performance level specified by the manufacturer when the equipment is used as intended. The performance level may be replaced by a permissible loss of performance. If the minimum performance level or the permissible performance loss is not specified by the manufacturer, then either of these may be derived from the product description and documentation, and by what the user may reasonably expect from the equipment if used as intended.

Performance criterion B

During the application of the disturbance, degradation of performance is allowed. However, no unintended change of actual operating state or stored data is allowed to persist after the test.

After the test, the equipment shall continue to operate as intended without operator intervention; no degradation of performance or loss of function is allowed, below a performance level specified by the manufacturer, when the equipment is used as intended. The performance level may be replaced by a permissible loss of performance.

If the minimum performance level (or the permissible performance loss), or recovery time, is not specified by the manufacturer, then either of these may be derived from the product description and documentation, and by what the user may reasonably expect from the equipment if used as intended.

Performance criterion C

Loss of function is allowed, provided the function is self-recoverable, or can be restored by the operation of the controls by the user in accordance with the manufacturer's instructions. A reboot or re-start operation is allowed. Information stored in non-volatile memory, or protected by a battery backup, shall not be lost.

11. ELECTROSTATIC DISCHARGE

11.1. Test Specification

Test standard	: EN 55035
Basic standard	: IEC 61000-4-2
Performance criterion	: B
Test level	: $\pm 8.0\text{kV}$ (Air discharge) $\pm 4.0\text{kV}$ (Contact discharge)

11.2. Block Diagram of Test Setup

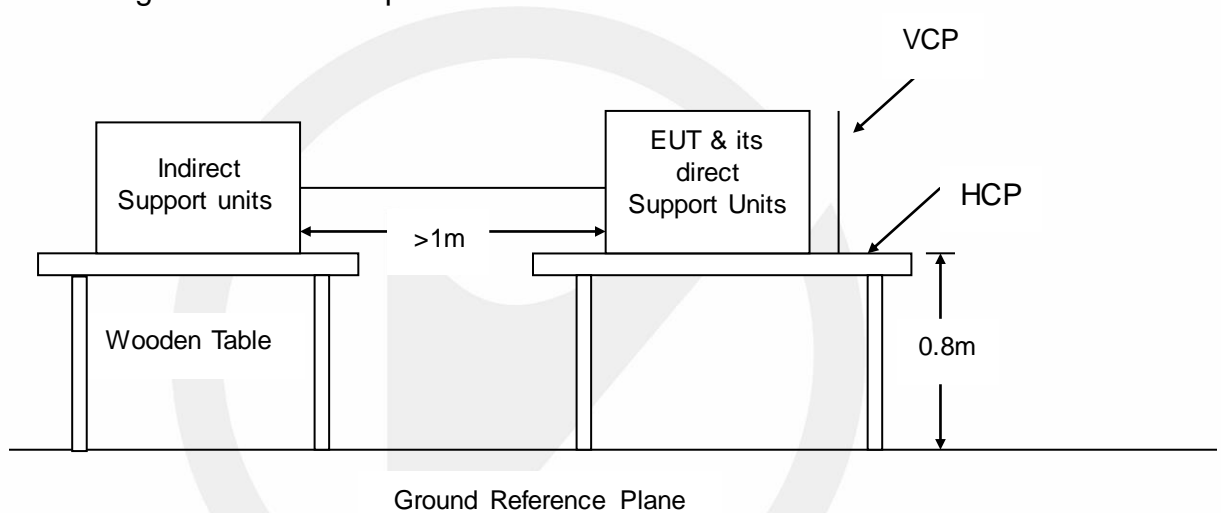

11.3. Test Procedure

- In the case of air discharge testing, the climatic conditions shall be within the following ranges:
 - ambient temperature: 15°C to 35°C;
 - relative humidity : 30% to 60%;
 - atmospheric pressure : 86 kPa (860 mbar) to 106 kPa (1060 mbar)
- Test programs and software shall be chosen so as to exercise all normal modes of operation of the EUT. The use of special exercising software is encouraged, but permitted only where it can be shown that the EUT is being comprehensively exercised.
- In the case of contact discharges, the tip of the discharge electrode shall touch the EUT before the discharge switch is operated.
- In the case of painted surface covering a conducting substrate, the following procedure shall be adopted :
 - If the coating is not declared to be an insulating coating by the equipment manufacturer, then the pointed tip of the generator shall penetrate the coating so as to make contact with the conducting substrate.
 - Coating declared as insulating by the manufacturer shall only be submitted to the air discharge.
 - The contact discharge test shall not be applied to such surfaces.
- In the case of air discharges, the round discharge tip of the discharge electrode shall be approached as fast as possible (without causing mechanical damage) to touch the EUT. After each discharge, the ESD generator (discharge electrode) shall be removed from the EUT. The generator is then retriggered for a new single discharge. This procedure shall be repeated until the discharges are completed. In the case of an air discharge test, the discharge switch, which is used for contact discharge, shall be closed.
- The test voltage shall be increased from the minimum to the selected test severity level, in order to

determine any threshold of failure. The final test level should not exceed the product specification value in order to avoid damage to the equipment.

g. The test shall be performed with both air discharge and contact discharge. The test shall be performed with single discharges. On each pre-selected point at least 10 single discharges (in the most sensitive polarity) shall be applied. For the time interval between successive single discharges an initial value of 1 s is recommended. Longer intervals may be necessary to determine whether a system failure has occurred.

h. Ensure that the applied charge on the EUT has been dis-charged before next ESD pulse.

11.4. Test Results

PASS

Temperature : 22.6°C
 Humidity : 51%
 Atmospheric Pressure : 101kpa
 Test Engineer : ZYC
 Test Date : 2024.6.2

Air Discharge:

Test Voltage	Location	Actual criterion	Required performance criterion	Result (Pass/Fail)
± 8kV	SLOT/LED/SIM/BUTTON	A	B	Pass

Contact Discharge

Test Voltage	Location	Actual criterion	Required performance criterion	Result (Pass/Fail)
± 4kV	METAL/SCREW/LAN/RF	A	B	Pass

Indirect Discharge

Test Voltage	Location	Actual criterion	Required performance criterion	Result (Pass/Fail)
± 4kV	HCP	A	B	Pass
± 4kV	VCP	A	B	Pass

Note:

A: During the test, the EUT has no performance degradation.

B: During the test, the EUT will shut down, after the test, it can automatic return to normal.

C: During the test, the EUT will shut down, after the test, it can return to normal by user.

12. CONTINUOUS RF ELECTROMAGNETIC FIELD DISTURBANCES

12.1. Test Specification

Test standard	: EN 55035	
Basic standard	: IEC 61000-4-3	
Performance criterion	: A	
Frequency range &	: <input checked="" type="checkbox"/> 80M-1000MHz	3V/m
Test level	: <input checked="" type="checkbox"/> Spot frequency	3V/m
	: <input type="checkbox"/> Additional spot frequency	3V/m
Modulation	: AM, 80%, 1kHz sine-wave	

12.2. Block Diagram of Test Setup

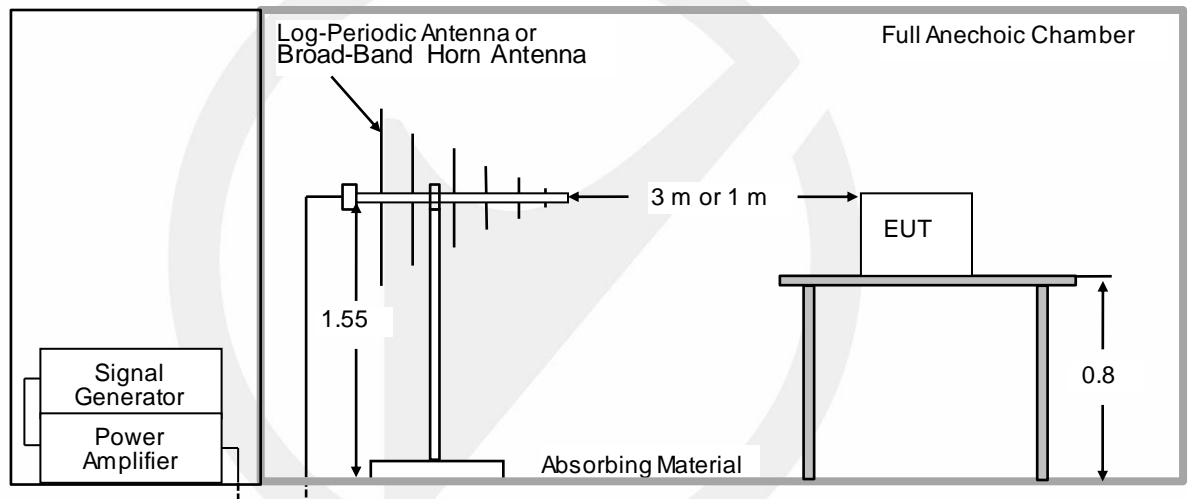

12.3. Test procedure

The procedure defined in this part requires the generation of electromagnetic fields within which the test sample is placed and its operation observed. To generate fields that are useful for simulation of actual (field) conditions may require significant antenna drive power and the resultant high field strength levels. To comply with local regulations and to prevent biological hazards to the testing personnel, it is recommended that these tests be carried out in a shielded enclosure or semi-anechoic chamber.

- a. The antenna which is enabling the complete frequency range of 80-1000 MHz is placed 3m (or 1m) away from the equipment. The required field strength is determined by placing the field strength meter(s) on top of or directly alongside the equipment under test and monitoring the field strength meter via a remote field strength indicator outside the enclosure while adjusting the continuous-wave to the antenna.
- b. The test is performed with the antenna facing the front and back sides of the EUT with. Both vertical and horizontal polarizations from antenna are tested.

12.4. Test results

PASS

Temperature : 23.7°C
 Humidity : 49%
 Atmospheric Pressure : 101kpa
 Test Engineer : ZYC
 Test Date : 2024.6.2

80M-1000MHz:

Freq. Range (MHz)	Field	Modulation	Polarity	Position (°)	Actual criterion	Required performance criterion	Result
80-1000	3V/m	AM, 80%	H / V	0, 90,180, 270	A	A	Pass

Spot frequency:

Freq (MHz)	Field	Modulation	Polarity	Position (°)	Actual criterion	Required performance criterion	Result
1800, 2600, 3500, 5000	3V/m	AM, 80%	H / V	0, 90,180, 270	A	A	Pass

Additional spot frequency:

Freq (MHz)	Field	Modulation	Polarity	Position (°)	Actual criterion	Required performance criterion	Result
80, 120, 160, 230, 434, 460, 600, 863, 900	3V/m	AM, 80%	H / V	0, 90,180, 270	N/A	A	N/A

Note:

A: During the test, the EUT has no performance degradation.

B: During the test, the EUT will shut down, after the test, it can automatic return to normal.

C: During the test, the EUT will shut down, after the test, it can return to normal by user.

13. ELECTRICAL FAST TRANSIENTS/BURST

13.1. Test Specification

Test standard	: EN 55035
Basic standard	: IEC 61000-4-4
Performance criterion	: B
Test level	: <input checked="" type="checkbox"/> 1kV, AC mains power ports <input type="checkbox"/> 0.5kV, DC network power ports <input checked="" type="checkbox"/> 0.5kV, Analogue/digital data ports
Repetition frequency	: <input checked="" type="checkbox"/> 5kHz, <input type="checkbox"/> 100kHz(Only xDSL ports)
Tr/Th:	: 5/50ns
Burst period	: 300ms
Test time :	: 120s

13.2. Block Diagram of Test Setup

AC Lines:

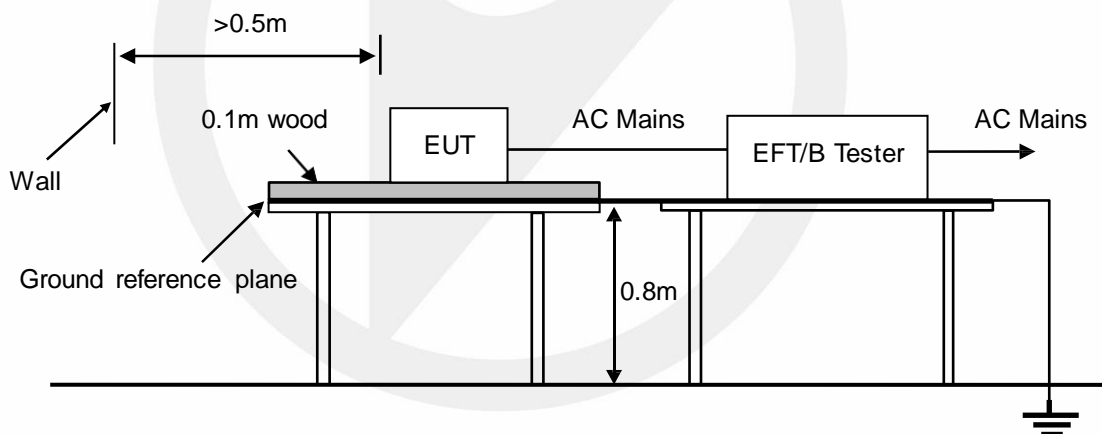

Signal lines:

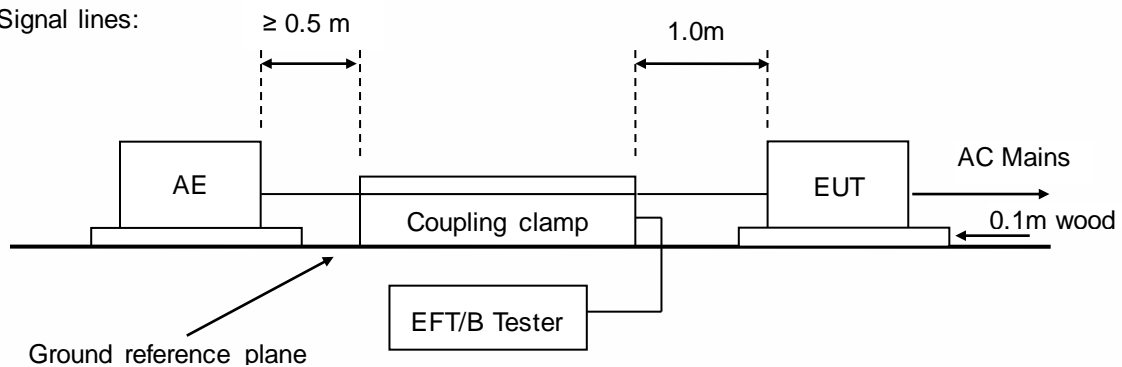

13.3. Test Procedure

The EUT is put on the table that is 0.8 meter high above the ground. This reference ground plane shall project beyond the EUT by at least 0.1m on all sides and the minimum distance between EUT and all other conductive structure, except the ground plane beneath the EUT, shall be more than 0.5m.

13.4. Test Results

PASS

Temperature : 22.9°C
 Humidity : 52%
 Atmospheric Pressure : 101kpa
 Test Engineer : ZYC
 Test Date : 2024.6.2

Injection Line	Voltage (kV)	Injected Method	Actual criterion	Required performance criterion	Result (Pass/Fail)
<input checked="" type="checkbox"/> AC mains power ports	± 1	<input checked="" type="checkbox"/> CDN <input type="checkbox"/> Direct injection <input type="checkbox"/> Capacitive coupling clamp	A	B	Pass
<input type="checkbox"/> DC network power ports	± 0.5	<input type="checkbox"/> CDN <input type="checkbox"/> Direct injection <input type="checkbox"/> Capacitive coupling clamp	N/A	N/A	N/A
<input checked="" type="checkbox"/> Analogue/digital data ports (Wired network port)	± 0.5	<input type="checkbox"/> CDN <input type="checkbox"/> Direct injection <input checked="" type="checkbox"/> Capacitive coupling clamp	A	B	Pass
<input type="checkbox"/> Analogue/digital data ports (Broadcast receiver tuner port)	± 0.5	<input type="checkbox"/> CDN <input type="checkbox"/> Direct injection <input checked="" type="checkbox"/> Capacitive coupling clamp	N/A	N/A	N/A

Note:

A: During the test, the EUT has no performance degradation.

B: During the test, the EUT will shut down, after the test, it can automatic return to normal.

C: During the test, the EUT will shut down, after the test, it can return to normal by user.

14. SURGES

14.1. Test Specification

Test standard	: EN 55035
Basic standard	: IEC 61000-4-5
Test level	: <input checked="" type="checkbox"/> 1kV, Line to Line, AC mains power ports, Criterion B <input checked="" type="checkbox"/> 2kV, Line to Earth, AC mains power ports, Criterion B <input type="checkbox"/> 0.5kV, Line to Reference ground, DC network power ports, Criterion B <input checked="" type="checkbox"/> 1.0kV, Lines to Ground, Unshielded symmetrical, Criterion C <input type="checkbox"/> 4.0kV, Lines to Ground, Unshielded symmetrical, Criterion C <input type="checkbox"/> 0.5kV, Shield to ground, Coaxial or shielded port, Criterion B
Number of surges	: 5 (for each combination of parameters)
Repetition rate	: 1 minute / time
Polarity:	: Positive / Negative
Phase angle:	: 0°, 90°, 180°, 270° (Only AC mains power ports)

14.2. Block Diagram of Test Setup

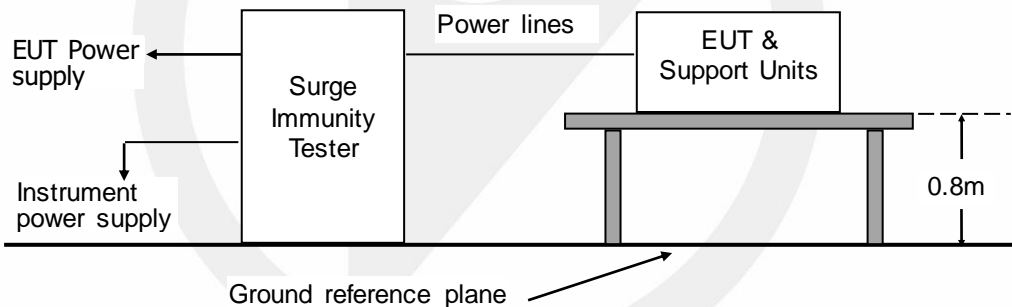

14.3. Test Procedure

This test simulates a lightning event by inducing transients onto the AC/DC power supply lines in common mode (Line to Ground) and differential mode (Line to Line). Each device was tested in a total of two surge configurations: Line to Ground (L-G): Combination Wave, Line to Protective Earth with 9uF and 10Ohm and Neutral to Protective Earth with 9uF and 10Ohm, common mode, generator earthed.

Line to Line (L-L): Combination Wave,

Line to Neutral with 18uF, differential mode, generator floated.

2 ohm : the source impedance of the low-voltage power supply network.

12 ohm : the source impedance of the low-voltage power supply network and ground.

- If not otherwise specified the surges have to be applied synchronized to the voltage phase at the zero-crossing and the peak value of the a.c. voltage wave (positive and negative).
- The surges have to be applied line to line and line to earth. When testing line to earth, the test voltage has to be applied successively between each of the lines and earth, if there is no other specification.
- The test procedure shall also consider the non-linear current-voltage characteristics of the equipment under test. Therefore the test voltage has to be increased by steps up to the test level specified in the product standard or test plan. All lower levels including the selected test level shall be satisfied.
- For testing the secondary protection, the output voltage of the generator shall be increased up to the worst-case voltage breakdown level (let-through level) of the primary protection.

- e. Testing shall be performed according to a Test Plan, which shall be included in the test report.
- f. To find all critical points of the duty cycle of the equipment, a sufficient number of positive and negative test pulses shall be applied.

14.4. Test results

PASS

Temperature : 22.9°C
 Humidity : 52%
 Atmospheric Pressure : 101kpa
 Test Engineer : ZYC
 Test Date : 2024.6.2

AC mains power ports:

Coupling Line	Voltage (kV)	Waveform (μs)	Polarity	Actual criterion	Required performance criterion	Result (Pass/Fail)
<input checked="" type="checkbox"/> Line to line	1	1.2/50 (8/20)	Pos./ Neg.	A	B	Pass
<input type="checkbox"/> Line to earth	2	1.2/50 (8/20)	Pos./ Neg.	N/A	B	N/A

DC network power ports:

Coupling Line	Voltage (kV)	Waveform (μs)	Polarity	Actual criterion	Required performance criterion	Result (Pass/Fail)
Line to Reference ground	0.5	1.2/50 (8/20)	Pos./ Neg.	N/A	B	N/A

Analogue/digital data ports:

Port type	Coupling Line	Voltage (kV)	Waveform (μs)	Polarity	Actual criterion	Required performance criterion	Result (Pass/Fail)
<input checked="" type="checkbox"/> Unshielded symmetrical (Wired network port)	Lines to ground	1	10/700 (5/320)	Pos./ Neg.	A	C	Pass
<input type="checkbox"/> Coaxial or shielded (Broadcast receiver tuner port)	Shield to ground	0.5	1.2/50 (8/20)	Pos./ Neg.	N/A	B	N/A

Note:

- A: During the test, the EUT has no performance degradation.
- B: During the test, the EUT will shut down, after the test, it can automatic return to normal.
- C: During the test, the EUT will shut down, after the test, it can return to normal by user.

15. CONTINUOUS INDUCED RF DISTURBANCES

15.1. Test Specification

Test standard	: EN 55035
Basic standard	: IEC 61000-4-6
Performance criterion	: A
Frequency range &	: 0.15M to 10MHz, 3V
Test level	: 10M to 30MHz, 3V to 1V
	: 30M to 80MHz, 1V
Modulation	: AM 80%, 1kHz sine-wave
Frequency Step	: 1% of fundamental

15.2. Block Diagram of Test Setup

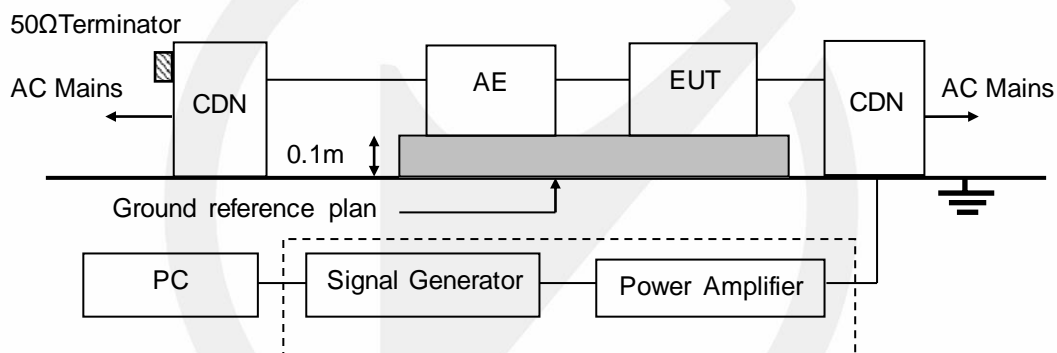

15.3. Test Procedure

- The EUT shall be operated within its intended climatic conditions. The temperature and relative humidity should be recorded.
- The EUT is placed on a 0.1m high test table, and a well grounded cable is connected to metallic plane above the test table.
- All cables/wires must be laid out on test plate (3cm in thickness), and the EUT is set up on test plate (10 cm in thickness) as shown in test setup photo, and the cables/wires must not be in mid-air, they should be touching the surface of test plate. Ensure that the EUT is properly connected to the accessory equipment.
- The test shall be performed with the test generator connected to each of the coupling and decoupling devices in turn while the other non-excited RF-input ports of the coupling devices are terminated by a 50 ohm load resistor.
- The frequency range is swept from 150 kHz to 80 MHz, using the signal levels established during the setting process, and with the disturbance signal 80% amplitude modulated with a 1 kHz sine wave, pausing to adjust the RF-signal level or to switch coupling devices as necessary. The rate of sweep shall no exceed 1.5×10^{-3} decades/s. Where the frequency is swept incrementally, the step size shall no exceed 1% of the start and thereafter 1% of the preceding frequency value.
- The dwell time at each frequency shall not be less than the time necessary for the EUT to be exercised, and able to respond. Sensitive frequencies e.g. clock frequency (ies) and harmonics or frequencies of dominant interest shall be analyzed separately.
- Attempts should be made to fully exercise the EUT during testing, and to fully interrogate all exercise modes selected for susceptibility

h. Testing shall be performed according to a Test Plan, which shall be included in the test report.

15.4. Test results

PASS

Temperature : 22.9°C
 Humidity : 52%
 Atmospheric Pressure : 101kpa
 Test Engineer : ZYC
 Test Date : 2024.6.2

Range (MHz)	Levers (V)	Injection port	Coupling type	Actual criterion	Required performance criterion	Result (Pass/Fail)
0.15-10	3	<input checked="" type="checkbox"/> AC mains power ports	<input checked="" type="checkbox"/> CDN <input type="checkbox"/> EM Clamp <input type="checkbox"/> Current Clamp <input type="checkbox"/> Direct injection	A	A	Pass
10-30	3-1					
30-80	1					
0.15-10	3	<input type="checkbox"/> DC network power ports	<input checked="" type="checkbox"/> CDN <input type="checkbox"/> EM Clamp <input type="checkbox"/> Current Clamp <input type="checkbox"/> Direct injection	N/A	N/A	N/A
10-30	3-1					
30-80	1					
0.15-10	3	<input checked="" type="checkbox"/> Analogue/digital data ports (Wired network port)	<input type="checkbox"/> CDN <input checked="" type="checkbox"/> EM Clamp <input type="checkbox"/> Current Clamp <input type="checkbox"/> Direct injection	A	A	Pass
10-30	3-1					
30-80	1					
0.15-10	3	<input type="checkbox"/> Analogue/digital data ports (Broadcast receiver tuner port)	<input type="checkbox"/> CDN <input type="checkbox"/> EM Clamp <input checked="" type="checkbox"/> Current Clamp <input type="checkbox"/> Direct injection	N/A	N/A	N/A
10-30	3-1					
30-80	1					
0.15-10	3	<input type="checkbox"/> Analogue/digital data ports (.....)	<input type="checkbox"/> CDN <input type="checkbox"/> EM Clamp <input checked="" type="checkbox"/> Current Clamp <input type="checkbox"/> Direct injection	N/A	N/A	N/A
10-30	3-1					
30-80	1					

Note:

- A: During the test, the EUT has no performance degradation.
- B: During the test, the EUT will shut down, after the test, it can automatic return to normal.
- C: During the test, the EUT will shut down, after the test, it can return to normal by user.

16. POWER FREQUENCY MAGNETIC FIELD

16.1. Test Specification

Test Standard	: EN 55035
Basic Standard	: IEC 61000-4-8
Performance criterion	: A
Test level	: 1A/m

16.2. Block Diagram of Test Setup

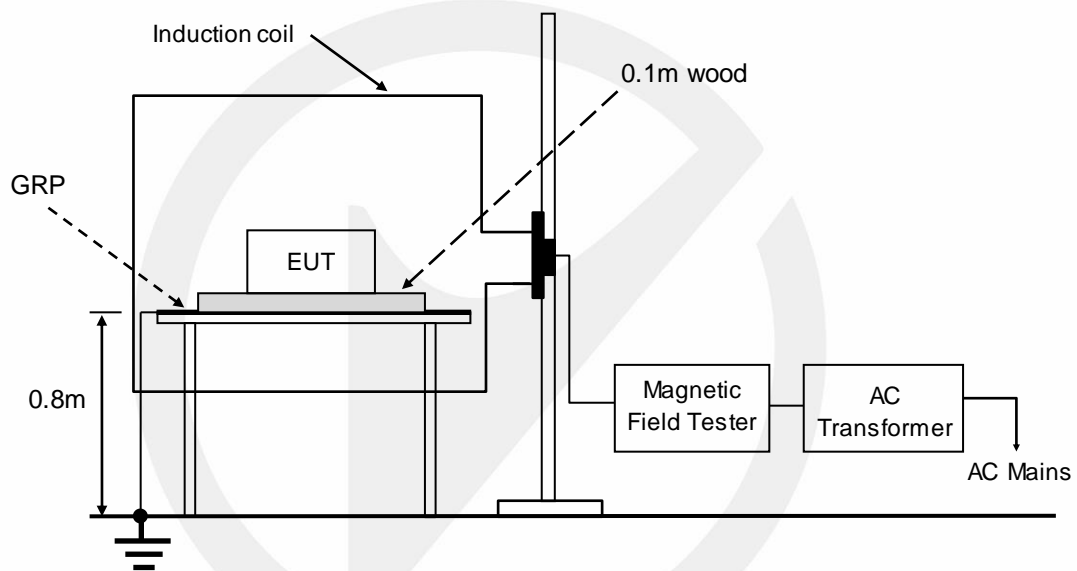

GRP: Ground reference plane
EUT: Equipment under test

16.3. Test Procedure

The EUT is placed in the middle of an induction coil (1*1m), under which is a 1*1*0.1m (high) table, this small table is also placed on a larger table, 0.8 m above the ground. Both horizontal and vertical polarization of the induction coil is set on test, so that each side of the EUT is affected by the magnetic field. Also can reach the same aim by change the position of the EUT.

16.4. Test Results

PASS

Temperature : 22.9°C
 Humidity : 52%
 Atmospheric Pressure : 101kpa
 Test Engineer : ZYC
 Test Date : 2024.6.2

Test Level (A/m)	Frequency	Testing Duration	Coil Orientation	Actual criterion	Required performance criterion	Result (Pass/Fail)
1	50Hz	5 mins	<input checked="" type="checkbox"/> x-axis <input checked="" type="checkbox"/> y-axis <input checked="" type="checkbox"/> z-axis	A	A	Pass

Note:

- A: During the test, the EUT has no performance degradation.
- B: During the test, the EUT will shut down, after the test, it can automatic return to normal.
- C: During the test, the EUT will shut down, after the test, it can return to normal by user.

17.VOLTAGE DIPS AND INTERRUPTIONS

17.1.Test Specification

Test standard	:	EN 55035
Basic standard	:	IEC 61000-4-11
Test level	:	0%, 0.5 period, Criterion B
		<input checked="" type="checkbox"/> 70%, 25 periods for 50Hz, Criterion C
		<input checked="" type="checkbox"/> 70%, 30 periods for 60Hz, Criterion C
		<input checked="" type="checkbox"/> 0%, 250 periods for 50Hz, Criterion C
		<input checked="" type="checkbox"/> 0%, 300 periods for 60Hz, Criterion C

17.2.Block Diagram of Test Setup

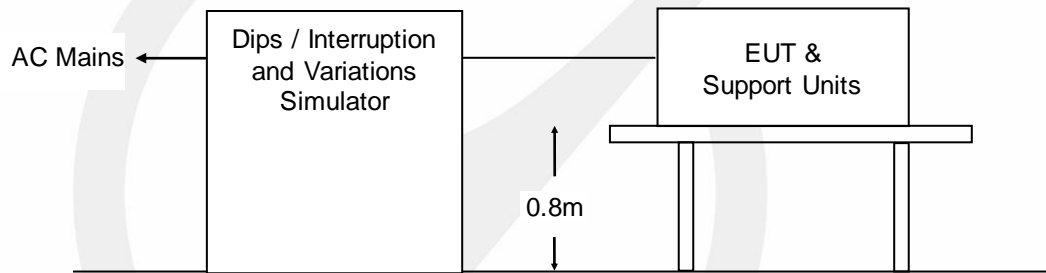

17.3.Test Procedure

- a. Where the equipment has a rated voltage the following shall apply - If the voltage range does not exceed 20% of the lower voltage specified for the rated voltage range, a single voltage within that range may be specified as a basis for test level specification.
 - In all other cases, the test procedure shall be applied for both the lowest and highest voltages declared in the voltage range.
- b. Test Conditions
 - Select operated voltage and frequency of EUT - Test of interval : 10 sec.
 - Level and duration : Sequence of 3 dips/interrupts.
 - Voltage rise (and fall) time : 1.5 μ s.

17.4. Test results

PASS

Temperature : 22.9°C
 Humidity : 52%
 Atmospheric Pressure : 101kpa
 Test Engineer : ZYC
 Test Date : 2024.6.2

	Test Level (% UT)	Phase angle (°)	Input Voltage (V)	Freq (Hz)	Duration (periods)	Actual criterion	Required performance criterion	Result (Pass /Fail)
<input checked="" type="checkbox"/> Voltage dips	0%	0°, 180°	AC 230V	50	0.5	A	B	Pass
<input checked="" type="checkbox"/> Voltage dips	70%	0°, 180°	AC 230V	50	25	A	C	Pass
<input checked="" type="checkbox"/> Voltage interruptions	0%	0°, 180°	AC 230V	50	250	B	C	Pass

Note:

- A: During the test, the EUT has no performance degradation.
- B: During the test, the EUT will shut down, after the test, it can automatic return to normal.
- C: During the test, the EUT will shut down, after the test, it can return to normal by user.

18.PHOTOGRAPHS

18.1.Photos of Conducted Emissions from the AC Mains Power Ports

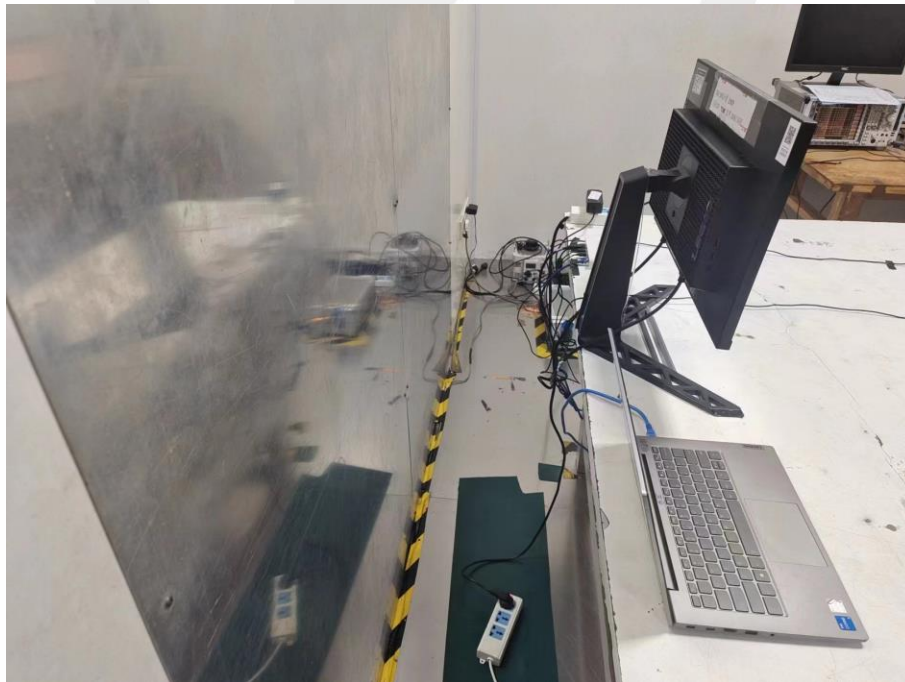
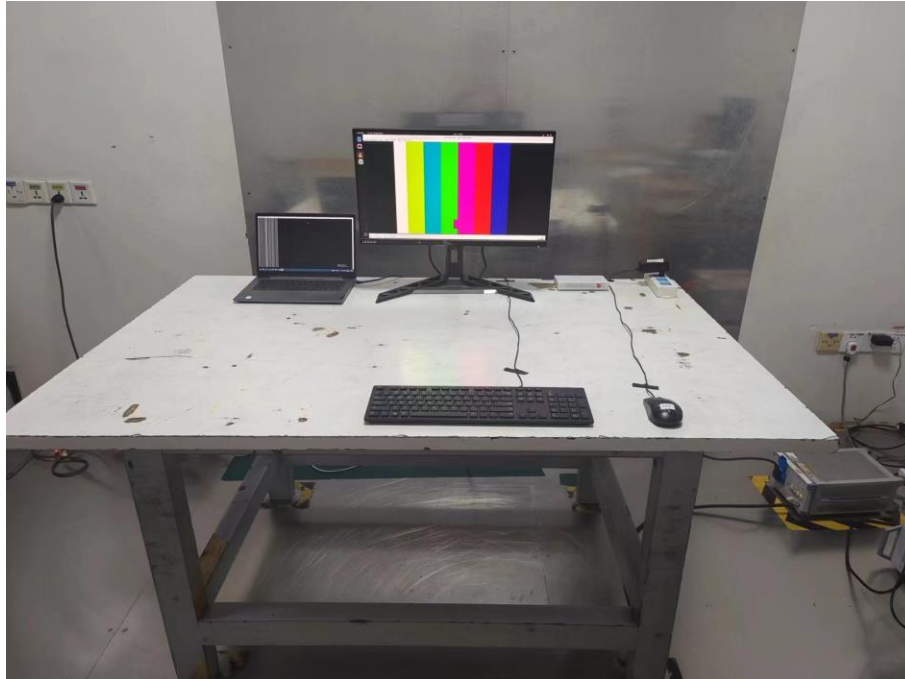

18.2.Photos of Asymmetric Mode Conducted Emissions at Wired Network Ports

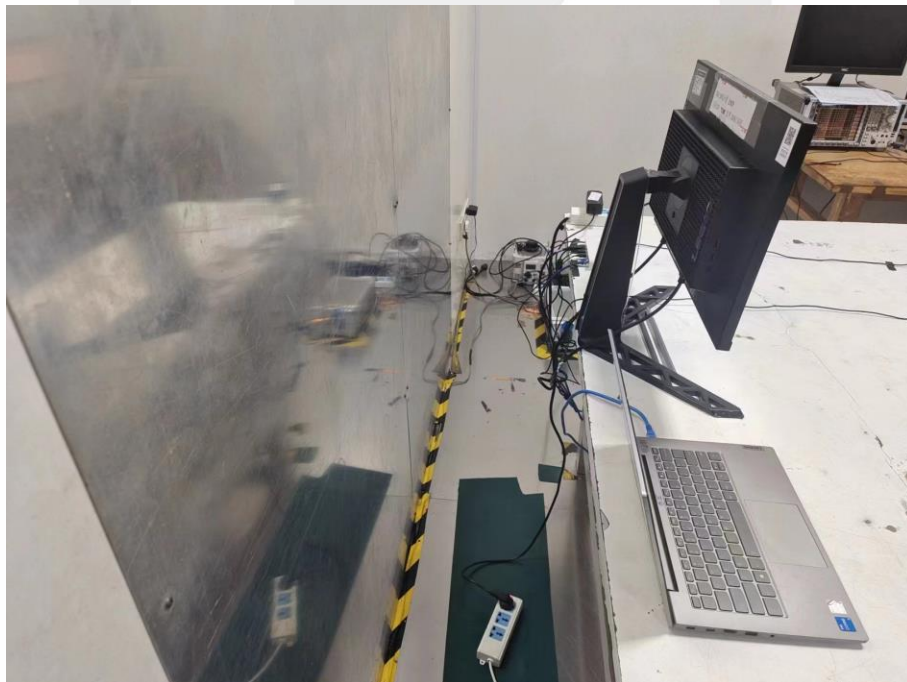

18.3.Photos of Radiation Emission Measurement

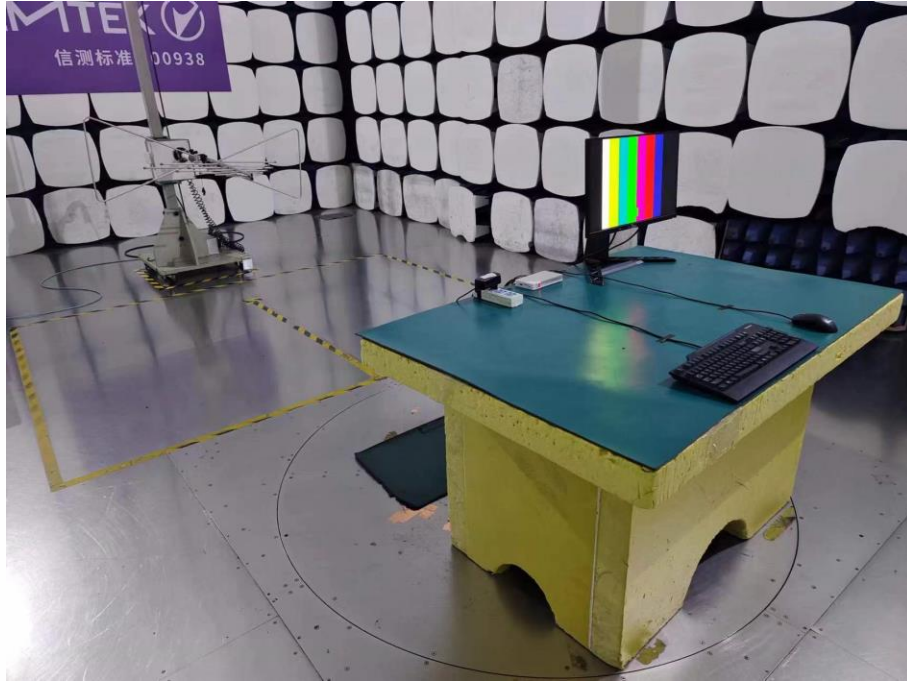

18.4. Photo of Harmonic / Flicker Measurement



18.5. Photo of Electrostatic Discharges



18.6. Photo of Continuous RF Electromagnetic Field Disturbances

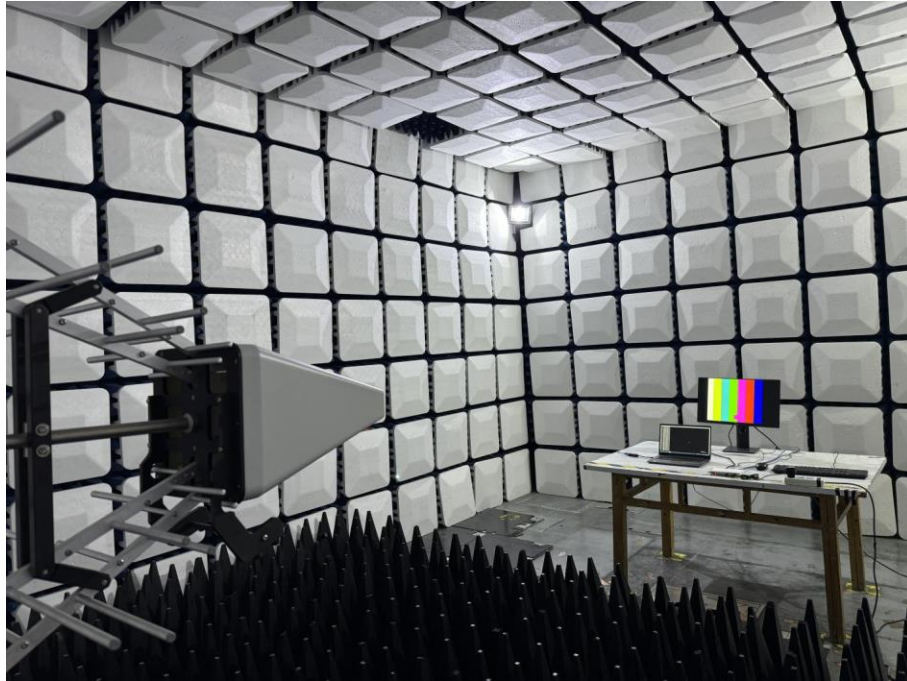

18.7.Photos of Electrical Fast Transients/Burst

AC Mains:



Analogue/digital data ports:



18.8.Photos of Surges

AC Mains:



Analogue/digital data ports:



18.9.Photos of Continuous Induced RF Disturbances

AC Mains:



Analogue/digital data ports:



18.10.Photo of Power Frequency Magnetic Field

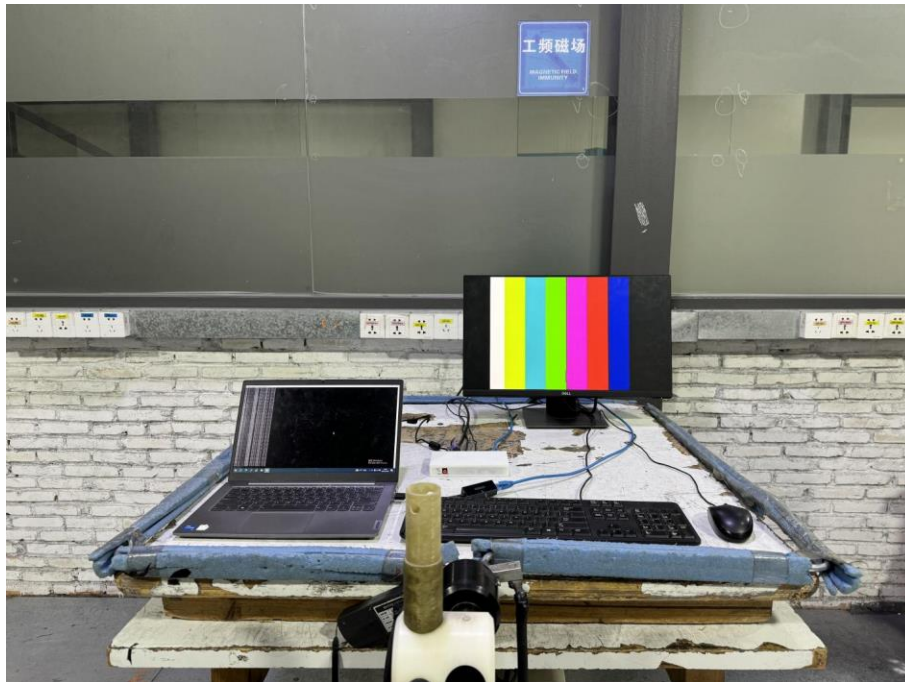

18.11.Photo of Voltage Dips And Interruptions



APPENDIX (PHOTOS OF EUT)



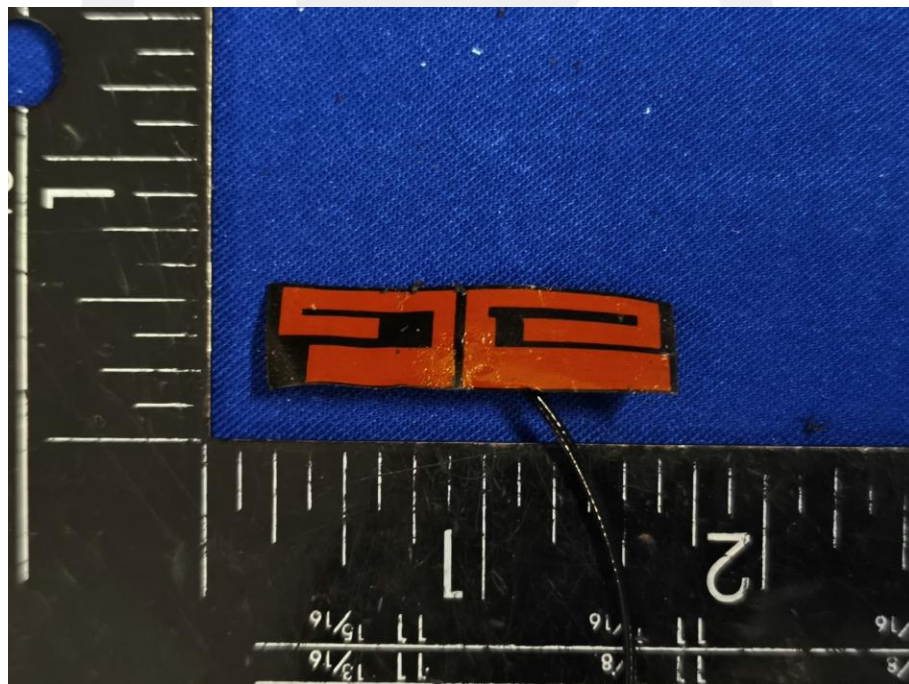
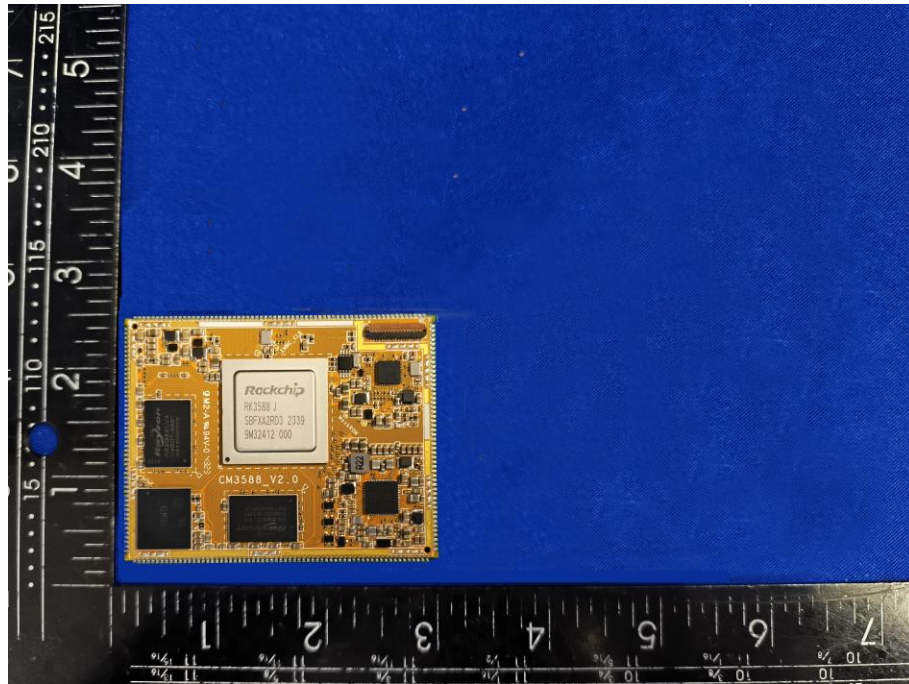

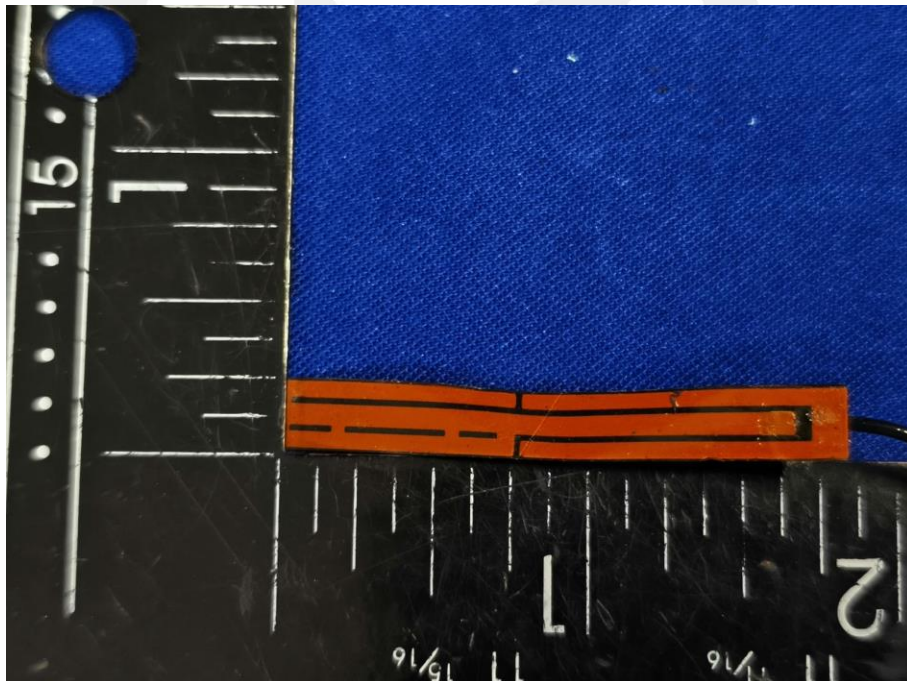
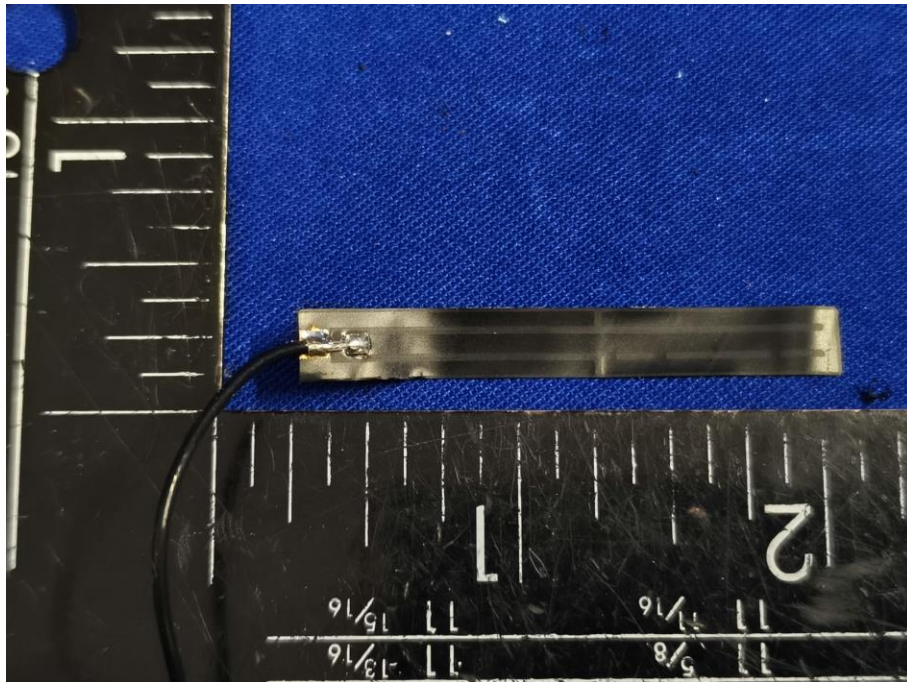

--- End of Report ---

声明 Statement

1. 本报告无授权批准人签字及“检验检测专用章”无效。
1. This report is invalid without the signature of the authorized approver and "special seal for testing".
2. 未经许可本报告不得部分复制。
2. This report shall not be copied partly without authorization.
3. 本报告的检测结果仅对送测样品有效，委托方对样品的代表性和资料的真实性负责。
3. The test results or observations are applicable only to tested sample. Client shall be responsible for representativeness of the sample and authenticity of the material.
4. 本检测报告中检测项目标注有特殊符号则该项目不在资质认定范围内，仅作为客户委托、科研、教学或内部质量控制等目的使用。
4. The observations or tests with special mark fall outside the scope of accreditation, and are only used for purpose of commission, research, training, internal quality control etc.
5. 本检测报告以实测值进行符合性判定，未考虑不确定度所带来的风险，本实验室不承担相关责任，特别约定、标准或规范中有明确规定的除外。
5. The test results or observations are provided in accordance with measured value, without taking risks caused by uncertainty into account. Without explicit stipulation in special agreements, standards or regulations, EMTEK shall not assume any responsibility.
6. 对本检验报告若有异议，请于收到报告之日起20日内提出。
6. Objections shall be raised within 20 days from the date receiving the report.